



B&W Trailer Hitches
 1216 Hawaii Road / PO Box 186
 Humboldt, KS 66748
 800.248.6564
 Fax:620.473.3766

hitches@turnoverball.com
 www.turnoverball.com

NOTE: We recommend reading instructions before beginning the installation.

WARNING: The tow vehicle's towing capacities should under NO circumstances be exceeded.

Turnoverball™ Gooseneck Hitch Installation Instructions

Model 1057R

Call or Email us for Installation Support

2007-2015 Chevrolet & GMC
1/2 Ton with boxed frame,
SHORT BED (LESS THAN 8')

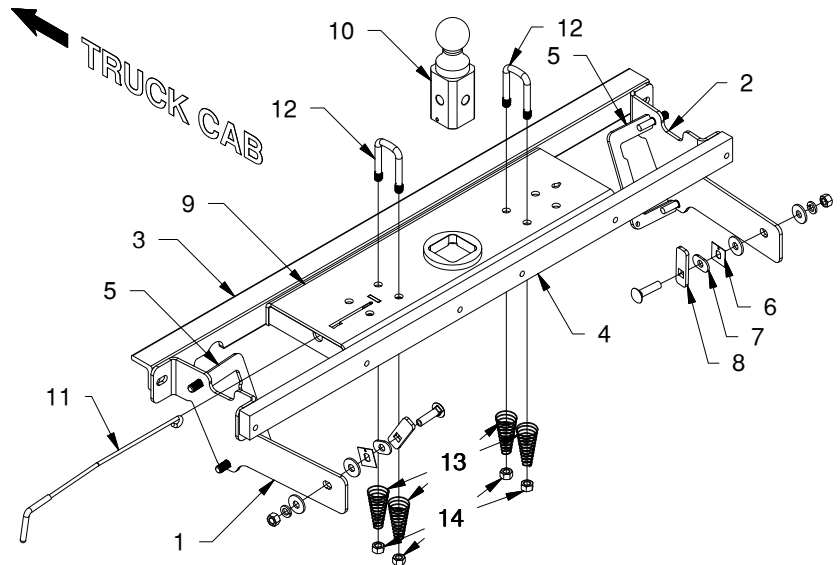

Mounting Kit Box (GNRM1057)		
ITEM	DESCRIPTION	QTY
1	Driver Side Plate	1
2	Passenger Side plate	1
3	Front Crossmember	1
4	Rear Crossmember	1
5	Sideplate Clamp	2

Mounting Kit Bolt Bag		
ITEM	DESCRIPTION	QTY
6	1/2" Retainer	2
7	1/2" Frame Bushing	2
8	1/2" Locking Strap	2
	1/2" X 2" Carriage Bolt	2
	1/2" X 1-1/2" Cap Screw	11
	1/2" Finish Nut	11
	1/2" Lock Washer	17
	1/2" Flat Washer	15
	O-Ring	1

Center Box (GNRC959N)		
ITEM	DESCRIPTION	QTY
9	Center Section	1
10	2-5/16" Ball	1
11	Latch Pin Handle	1

Safety Chain Kit Bolt Bag		
ITEM	DESCRIPTION	QTY
12	1/2" U-Bolt	2
13	Conical Springs	4
14	1/2" Lock Nut	4
	5/16" X 3/4" Carriage Bolt	1
	5/16" X 3/4" Cap Screw	1
	5/16" Lock Nut	1

NOTICE: This product was designed to fit vehicles in their original, "as manufactured" condition. Compatibility with vehicles having replacement parts, or other modifications is not guaranteed. Inspect vehicle for modifications before installation of this product.

BEFORE INSTALLING OVERHEAD LIFTING DEVICE

An overhead-lifting device, such as chain falls, engine hoist, or cable come-a-long, can be used to lift the center section of the hitch in place. Lower a loop of rope or chain through the 4" hole in the truck bed floor and attach it to the latch pin in the round hitch receiver tube in the center section. Use the lifting device to raise the center section until the round hitch receiver tube that protrudes from the center section fits in the 4" hole in the truck bed floor. Maintaining upward pressure may facilitate fastening the crossmember to the center section, especially if the truck bed floor has been distorted downward from heavy use. If you use an overhead-lifting device, it should be disconnected before squaring the center section across the frame, installing the sideplates and torquing fasteners.

WARNING

Most trucks have FUEL LINES and/or BRAKE LINES and/or ELECTRICAL WIRES located along the frame rails where B&W Turnoverball™ hitches install. Carefully examine the location of fuel lines, brake lines and electrical wires BEFORE INSTALLATION. Be certain you will not damage fuel lines, brake lines or electrical wires when positioning hitch components, drilling holes and tightening fasteners. The fuel tank vent, located on top of the gas tank, can be easily damaged during the installation of the hitch components. Care must be taken when positioning the front crossmember and center section components.

APPLICATION UPDATE:

Beginning in 2004, a fuel valve mounted on the rear of the fuel tank on trucks equipped with gas engines, makes it more difficult to install the Turnoverball™ center section. This fuel valve can be easily removed and replaced to ease installation. Please follow the following instructions:



Step 1:
Locate the fuel valve.



Step 2:
Disengage the locking pin.



Step 3:
Slide fuel valve from bracket.



Step 4:
Install Turnoverball™ Center Section.

Step 5: Replace fuel valve to bracket on fuel tank.

*****HAND TIGHTEN ALL HARDWARE IN STEPS 6 THROUGH 9*****

STEP SIX - CENTER SECTION INSTALLATION

Raise the center section into position between the cross-members and carefully move it above the fuel tank from beneath the truck. The receiver socket must be positioned to the rear with the latch pin release arm on the driver's side. A lifting device, as described on Page 2 will help. The round hitch receiver that protrudes from the top of the center section must fit through the hole in the truck bed floor. Slide the front cross member back against the center section so that the bolt installed previously in the front cross member goes into the center section hole directly across from it. Line up the rest of the holes and attach the two members with 1/2" x 1 1/2" long bolts, lock washers, and nuts. Insert four 1/2" x 1 1/2" bolts, with flat and lock washer installed, through the rear leg of the center section into the threaded holes of the rear crossmember and hand tighten.



STEP SEVEN - INSTALL SIDEPLATE STUDS

Locate indicated hardware needed for this step and have it handy. Next, locate oval hole on the outside of the frame. It is located about 4 inches behind the axle and measures roughly 1" x 1 1/2". To begin, place carriage bolt through hole in locking strap. Next, hold the bolt and locking strap by only the bolt threads. Insert the long end of the locking strap into the hole in the frame. Continue to move the locking strap into the frame until the head of the bolt passes into the oval hole. Maneuver the bolt until the entire locking strap is inside the frame. Continue to hold onto the threads of the bolt. With your free hand place the frame bushing over the threads and carefully move it into the oval in the frame. This will insure that the bolt is centered in the slot. Once you are sure the frame bushing is inside the oval hole and against the locking strap, thread the retainer onto the bolt threads. Tighten retainer so bolt is held securely to the frame. If necessary, a screwdriver may be used in the small slot provided to turn the retainer to make it tight.

HARDWARE NEEDED FOR THIS STEP

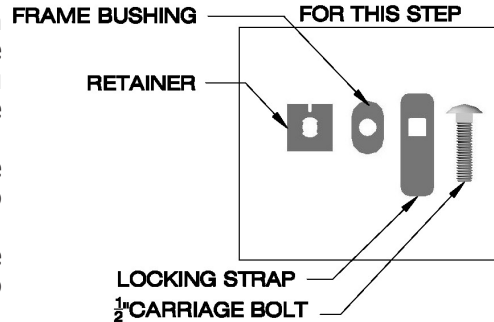

INSERT LOCKING STRAP AND BOLT

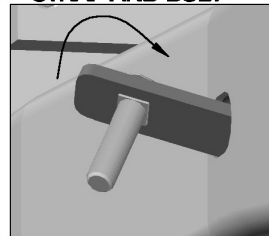

ROTATE LOCKING STRAP AND BOLT

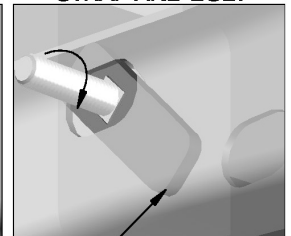

ROTATE THE LOCKING STRAP CLOCKWISE UNTIL IT HITS THE BOTTOM OF THE TRUCK FRAME

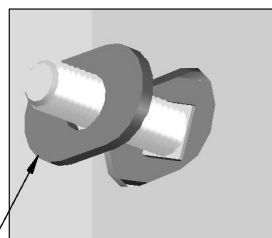

INSERT FRAME BUSHING MAKING SURE IT CENTERED IN THE FRAME SLOT

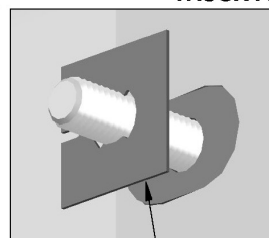

RETAINER

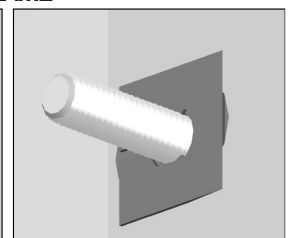

Warning

On Short bed trucks, BEFORE INSTALLING THIS HITCH, check for adequate turning clearance between the front of all of your trailers and the truck cab.

Warning

DO NOT invert the ball in the socket when carrying heavy loads on 2 wheel drive trucks. The ball may hit the top of the differential. Remove the ball from the socket before loading. A plug for the socket is available from B & W.

INSTALLATION INSTRUCTIONS

STEP ONE - REMOVE SPARE TIRE AND HEAT SHIELD

Removing the spare tire will ease in the installation of the hitch. Refer to the owner's manual for the spare tire removal instructions. A section of the exhaust heat shield will need to be removed. Locate the bed crossmember that is directly over the axle and the next one forward (toward the front of the truck). The section of heat shield between these two crossmembers will have to be removed. This can be removed by cutting along the crossmembers with tin snips or an air chisel. Make sure that none of the heat shield is protruding past the front of the bed crossmember that is directly over the axle this could interfere with the rear hitch crossmember.



STEP TWO - REMOVE EXHAUST HANGER

To ease in the installation of the center section remove the tail pipe hanger from the rubber mount. Simply pry the pin on the hanger out of the rubber mount. Once this is done a spacer can be placed between the frame and tail pipe to add clearance between the tail pipe and the bottom of the truck bed.

STEP THREE - MARKING AND CUTTING 4 INCH HOLE IN TRUCK BED

Begin by measuring for the correct hole location in the truck bed floor. Measure from the tail gate end of the truck bed floor by hooking a tape measure over the end of the truck box and mark the floor at the correct measurement (See below). Next find the center point between the wheel wells, where these marks intersect with the first measurement will be the center point of your four inch hole. This Location is critical to the correct installation of the B & W Turnover-ball™ so measure, mark and saw carefully. Make a four inch hole at this location. B & W recommends using a four inch hole saw, however the hole can be cut by other means. If your truck has a spray-in bed liner you will need to take into account when you are measuring to add the thickness of the applied liner that has been sprayed over the end of the bed. If your truck has a drop-in plastic bed liner, you may saw through both, but it is more difficult to accurately locate the midpoint between the fender wheel wells, and to be sure that the bed liner does not move when sawing the hole. Once you have the four inch hole in the bed use a deburring tool or a die grinder and carefully remove the burr from the under side of the bed around the hole.

TIP: B & W uses a 2"x 8"x 30" board with a 4" hole pre-drilled in it as a drilling guide to prevent the hole saw from moving while sawing the four inch hole in the bed.

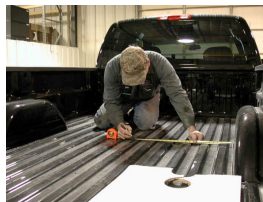
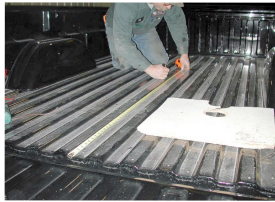

**4" HOLE LOCATION
SHORT BED (BED LESS
THAN 8' LONG) - 44 1/8"**

STEP FOUR - BED FLANGE MODIFICATION

The gap between the bed and frame is large enough to allow installation of the crossmembers, but the gap is partially obstructed by a sheet metal flange (about 1 inch in height) that is hanging down from the bottom of the truck bed floor. (See diagram). A small notch needs to be made in this flange on the Passenger's side of the truck. Locate the truck bed cross member over the axle in the wheel well on the passenger side of the truck. Measure from the front of the cross member and make a mark at 6 1/2". This will be the center point for the notch that is needed. Mark and cut a 1" wide by 1/2" tall notch.

BED FLOOR FLANGE IN PASSENGER'S SIDE WHEEL WELL

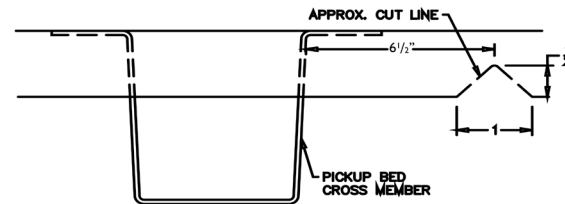

STEP FIVE - CROSSMEMBER INSTALLATION

Slide the angle iron cross member between the truck frame and the bed using the notch that was made in step four. Be sure the holes in the cross member are facing the rear of the truck. Once you start sliding the angle across the frame of the truck, we recommend that you get under the truck and guide it across the frame rails taking care not to damage the brake lines along the driver side of the frame or fuel valve located on the back of the fuel tank on some models. Once the crossmember is across the frame rails using the rubber O-ring provided, secure a 1/2" 1-1/2" long bolt into the second hole in the cross member from the drivers side. Next push the crossmember forward until the crossmember is about four inches in front of the four inch hole in the truck bed, making sure that the notch in the angle carefully goes over the brake lines and wiring harness. Next install the cross member bar between the truck frame and the bed. Start sliding the bar across the frame then get under the truck to guide the bar across the frame of the truck. Next rotate the bar a quarter turn so the threaded holes are toward the bottom (an adjustable wrench can aid in rotating the bar). Then slide the bar toward the back of the truck until it is against the bed cross member.

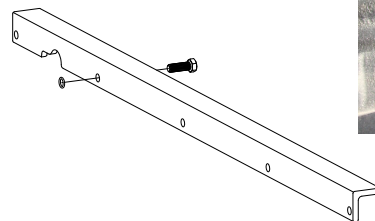

STEP EIGHT - INSTALL SIDEPLATES

Place a 1/2" flat washer over the stud installed in the frame. This will allow the sideplate to sit uniformly when tightened against the weld at the bottom of the frame. Next, guide the rear most hole in the sideplate over the stud. Secure with a flat washer, lock washer, and 1/2" nut. Hand tighten until the sideplate is against the frame and flat washer on the stud assembly. Attach the front flange of the side plate to the front angle crossmember. Place a 1/2" by 1 1/2" bolt with a flat washer though the flange and the front angle then secure with a lock washer and nut. Next attach the sideplate to the rear bar by placing a 1/2" x1 1/2" bolt with a flat washer, and lock washer though the smaller side plate flange and threading it into the threaded hole in the bar.

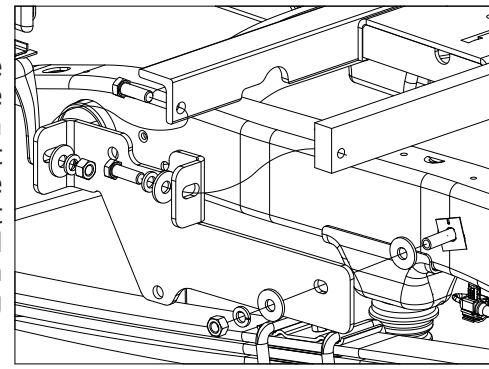

STEP NINE - SIDEPLATE CLAMP INSTALLATION

Install the sideplate clamp on the driver's side. The sideplate clamp has two studs welded on the legs that will pass through the remaining holes in the side plate. There is a notch cut in the top inner part of the clamp that will allow clearance for the brake lines on the top of the frame. The small hole in the clamp should be toward the bottom. Slide the sideplate clamp between the wiring harness and the inside of the frame making sure the top part of the clamp goes over the brake lines. Push the clamp outward placing the studs through the holes in the side plate. Be careful not to damage brake lines or wires. The sideplate clamp will set at a diagonal when installed correctly. Place a 1/2" lock washer and nut on the studs. Fit the second clamp around the passenger side frame and into the holes in the passenger sideplate in the same way. Place a lock washer & nut on each of the threaded ends of the clamp once they have been installed through the side plate holes.



STEP TEN - TIGHTEN HARDWARE

It is very important to tighten hardware in the proper sequence. First check to insure that the hitch crossmembers are spaced about the same from side to side on the frame. Then tighten the center section bolts to 80 ft. lbs. Next tighten the sideplate clamps by alternating slowly between the top and bottom legs so they are equally tightened to 40 ft. lbs. tighten the bolts holding the side plates to the front and rear hitch crossmembers to 80 ft. lbs. then tighten the rear side plate studs to 80 ft. lbs.

STEP ELEVEN - INSTALL LATCH PIN RELEASE HANDLE

WARNING: LATCH PIN WILL NOT FUNCTION PROPERLY IF HANDLE IS NOT INSTALLED CORRECTLY.

Install the latch pin release handle by inserting it through the slot in the end of the center section on the driver's side of the truck. Align the handle eyelet with the square hole in the latch pin so the handle is in line with the latch pin as shown. Secure the handle to the pin with the 5/16 X 3/4" carriage bolt and 5/16" locking flange nut as shown. Note: The included 5/16" cap screw can replace the carriage bolt if wrench access on the "cab side" of the handle is limited. Tighten the nut until it is secure. Do not over-tighten and deform the handle eyelet.

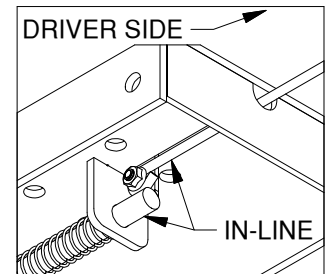
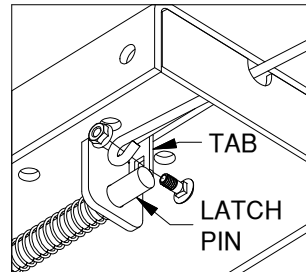

STEP TWELVE - INSTALL SAFETY CHAIN U-BOLTS

To install the safety chain U-bolts it is necessary to drill four 1/2" holes through the truck bed floor. Drill the holes from beneath the truck, through the two holes located on each side **and closest to the round receiver tube in the center section**. This will locate the safety chain U-bolt in the lowest point of the floor corrugation. Drop a U-bolt through each pair of holes from the topside of the truck bed floor. Place a spring and lock nut on each of the four legs. Tighten the lock nuts until flush with the bottom of the U-bolts.



STEP THIRTEEN- REPLACE THE EXHAUST BRACKET

Re-attach the exhaust to the hanger bracket and replace spare tire if removed during the installation.