



TORKLIFT

I N T E R N A T I O N A L

OVER 35 YEARS OF INNOVATION, QUALITY, SAFETY.



TRUE FRAME MOUNTED CAMPER TIE DOWNS

IMPORTANT OWNER-OPERATOR INSTALLATION INSTRUCTIONS

C4204



REVISED vers5 BY: JL 8/6/15

TECH SUPPORT (800) 246-8132

**AFTER INSTALL, PLEASE GIVE
THIS BOOKLET TO YOUR CUSTOMER**

Warnings

Truck Bed and Camper Protection

Torklift **does not** recommend installing your camper on top of a plastic bed liner (or other compressible material such as foam). These materials can act as a spring, causing increased vertical truck camper movement independent of the vehicle. Plastic bed liners can slide on the truck bed surface, and the truck camper can slide on top of the bed liner. Using a plastic bed liner or similar compressible material will void your warranty and may additionally cause truck bed and/or camper damage.

Minor movement or settling can occur in some incidental harsh driving conditions (on or off-road). A rubber bed mat is recommended to protect the truck bed and camper, but is not a requirement to maintain the Torklift legendary lifetime warranty.

Suspension

To significantly reduce body roll, sag and sway Torklift strongly recommends the StableLoad. Torklift International StableLoads improve safety, handling, and to help level your truck. More information can be found at (www.Torklift.com/stableload).

If your truck is additionally equipped with suspension air bags Torklift cautions against over pressurization as this may lead to unsafe vehicle handling characteristics. We have found that airbags used in conjunction with StableLoads have allowed operators to lower air bag pressure by 50% or more. Only pressurize suspension air bags enough to level the truck.

C4204 INVENTORY LIST

6- 1/2" -13 X 3-1/2" GR8 HEX BOLT	2- 3/4" -10 X 4-1/2" GR8 HEX BOLT
6- 1/2" -13 X 1-1/4" GR5 HEX BOLT	8- 1/2" -13 NUT -FLANGE SERRATED GR5
4- 1/2" -13 NUT -HEX GR8	4- 1/2" WASHER-LOCK GR5
2- 1/2" WASHER GR5	4- 1/2" WASHER -STAR GR5
2- 3/4" -10 NUT-HEX JAM GR5	2- 3/4" WASHER -LOCK GR5
2- 3/4" WASHER GR5	2- 1/4" X 2-1/4" SNAPPER PIN
2- 16-1/2" BENT INSERTS	2- FRAME UNITS
2- HOOK BOLTS	2- THREE HOLE STRAP PLATE
2- ADJUSTABLE MOUNTING PLATE	2- 7"(18cm) ZIP TIES
2- 2-1/2" X 2-1/2" X 7"(18cm) SQUARE TUBING	

INSTALLATION INSTRUCTIONS:

LOCATE AND INVENTORY ALL PARTS TO BECOME FAMILIAR WITH ALL BRACKETS. READ AND UNDERSTAND ALL INSTRUCTIONS. MAKE SURE THE VEHICLE IS IN PARK, ON A LEVEL SURFACE AND WHEELS ARE CHOCKED BEFORE STARTING THE INSTALLATION. * NOTE: SOME VEHICLES ARE SLIGHTLY DIFFERENT; LOOK FOR THE BED MOUNT PERCH FOR REFERENCE POINT.

STEP 1

Locate the driver's side rear cab mount and drivers side front bed cross member perch. Using one 3-hole strap, insert one 1/2" -13 x 3-1/2" GR8 bolt and one 1/2" star washer onto the last oval slot. Place the 3 hole strap behind the bed cross member perch with the bolt protruding to the outside. (The oval hole to the rear of the vehicle, with the 1/2" hole towards the front of the vehicle) place one 5/16" hook bracket onto the 1/2" -13 x 3-1/2" GR8 bolt, hooking it to the bed mount perch. **SEE PHOTO A, B & C**

STEP 2

Zip tie e-brake cables between the cab mount and the bed mount. Then locate the driver's side 3 hole angle tie down frame plate. Just below the cab mount perch, line up the 3/4" hole in the 3-hole angle tie down frame plate with the hole in the frame. (The angle with the two holes facing rear-ward) insert the supplied 3/4" x 4-1/2" GR8 bolt through the hole. On the back side of the frame in front of the fuel tank, place one 3/4" flat washer, one 3/4" lock washer and one 3/4" Jam nut onto the 3/4" x 4-1/2" GR8 bolt. Hand tighten. **SEE PHOTO D, E & F**

STEP 3

Next, locate the driver's side tie down frame plate and place it in the gap between the cab mount and the bed mount perch. Line up the top hole on the tie down frame plate with the 3-hole strap. Place one 1/2" -13 x 1-1/4" GR5 bolt and one 1/2" star washer through the 3-hole strap and tie down frame plate. Install one 1/2" flat washer, one 1/2" lock washer and one 1/2" GR5 hex nut onto the previously installed bolt. **SEE PHOTO G, H**

STEP 4

Line up the tie down frame plate with the cab tie down frame plate, place one 1/2" -13 x 1-1/4" GR5 bolt through each hole in the 3-hole tie down frame plate. Fasten with 1/2" GR5 serrated nut. Hand tighten. **SEE PHOTO I & J**

STEP 5

Locate the 2-1/2" X 2-1/2" X 7"(18cm) square tubing receiver and place between the side plates on the tie down frame plate. Take two 1/2" -13 X 3-1/2" GR8 hex bolts and two 1/2" GR5 serrated nut and place through the holes with the best angle. **SEE PHOTO J**

STEP 6

Press up on the bottom of both tie down frame plates and tighten the previously installed 1/2" fasteners from step 4.

** NOTE: THE E-BRAKE CABLE MAY RUB AGAINST THE TIE DOWN RECEIVER. THIS IS OKAY DUE TO THE PROTECTIVE PLASTIC AND RUBBER COATING CHEVROLET PUTS ON THEIR BRAKE LINES*

***FOR ADDING RECIEVER AND FOR ADJUSTMENTS, GO TO
PAGE 10***

STEP 7

For passenger side installation, repeat steps 1-8 on passenger side.

STEP 8

Tighten all GR5 fasteners to 60 ft-lbs(81nm) with a Torque Wrench.

Tighten all GR8 fasteners to 60 ft-lbs(81nm) with a Torque Wrench.

**** NOTE: ALL PHOTOS ARE OF DRIVERS SIDE INSTALLATION***

PHOTO A

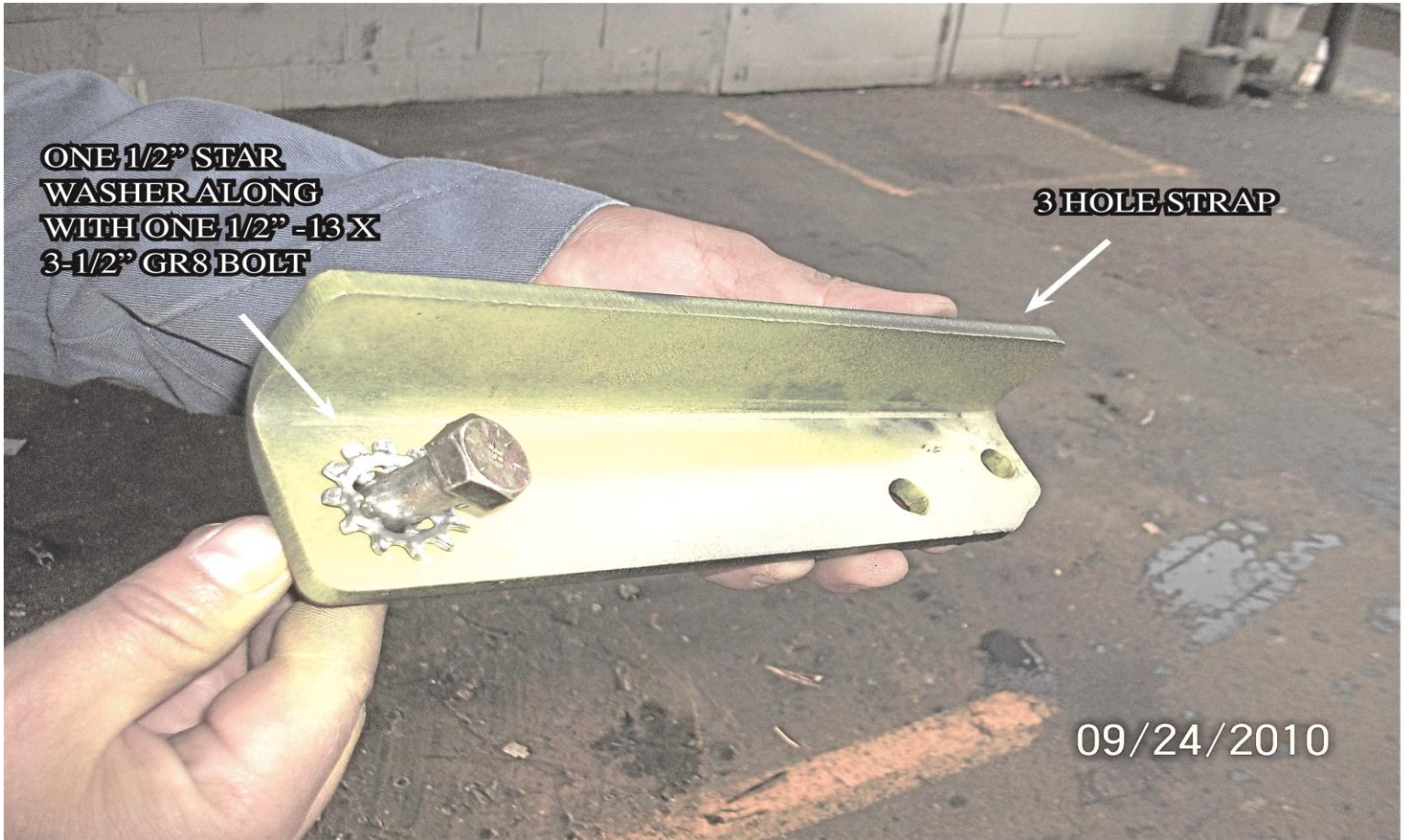

PHOTO B

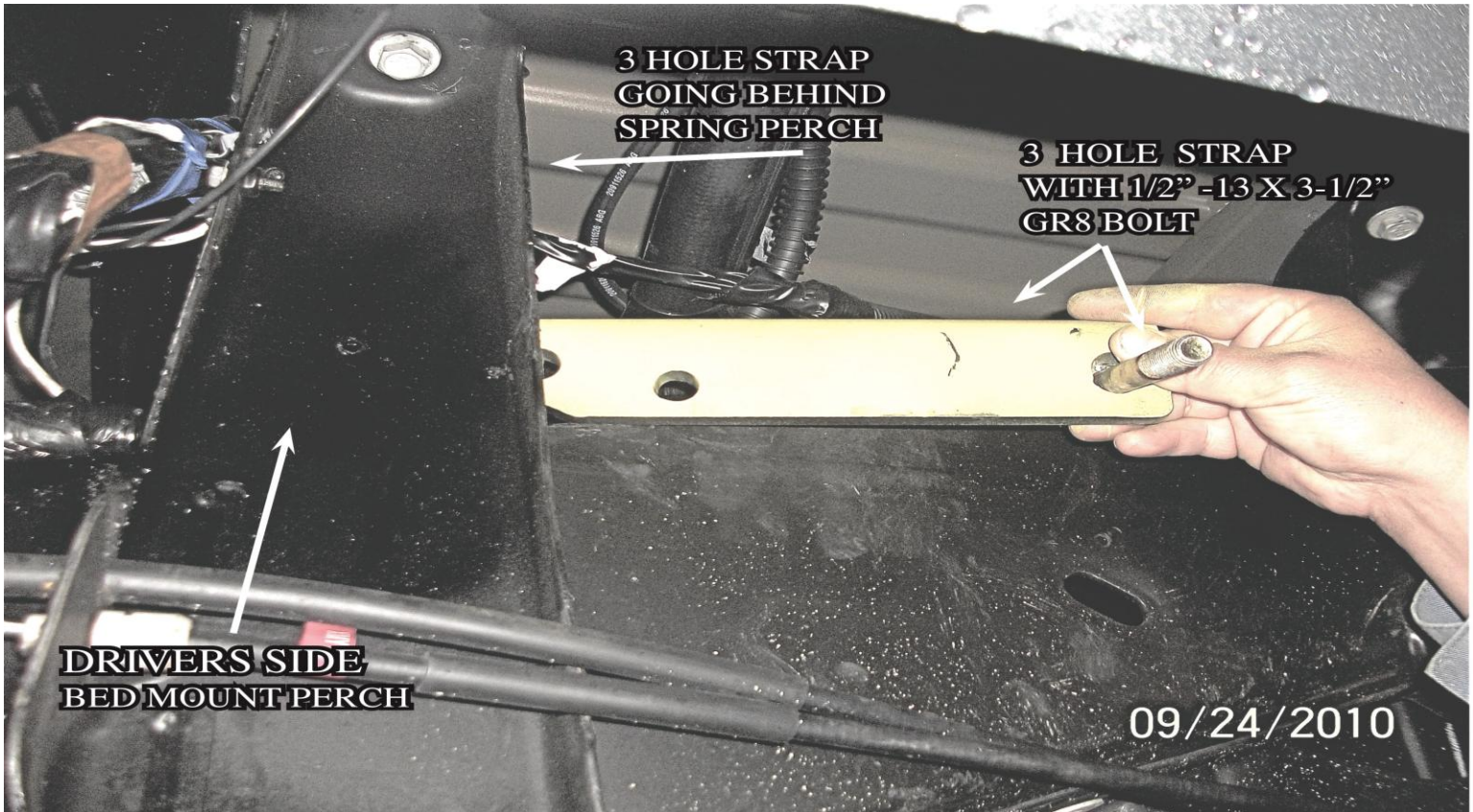

PHOTO C

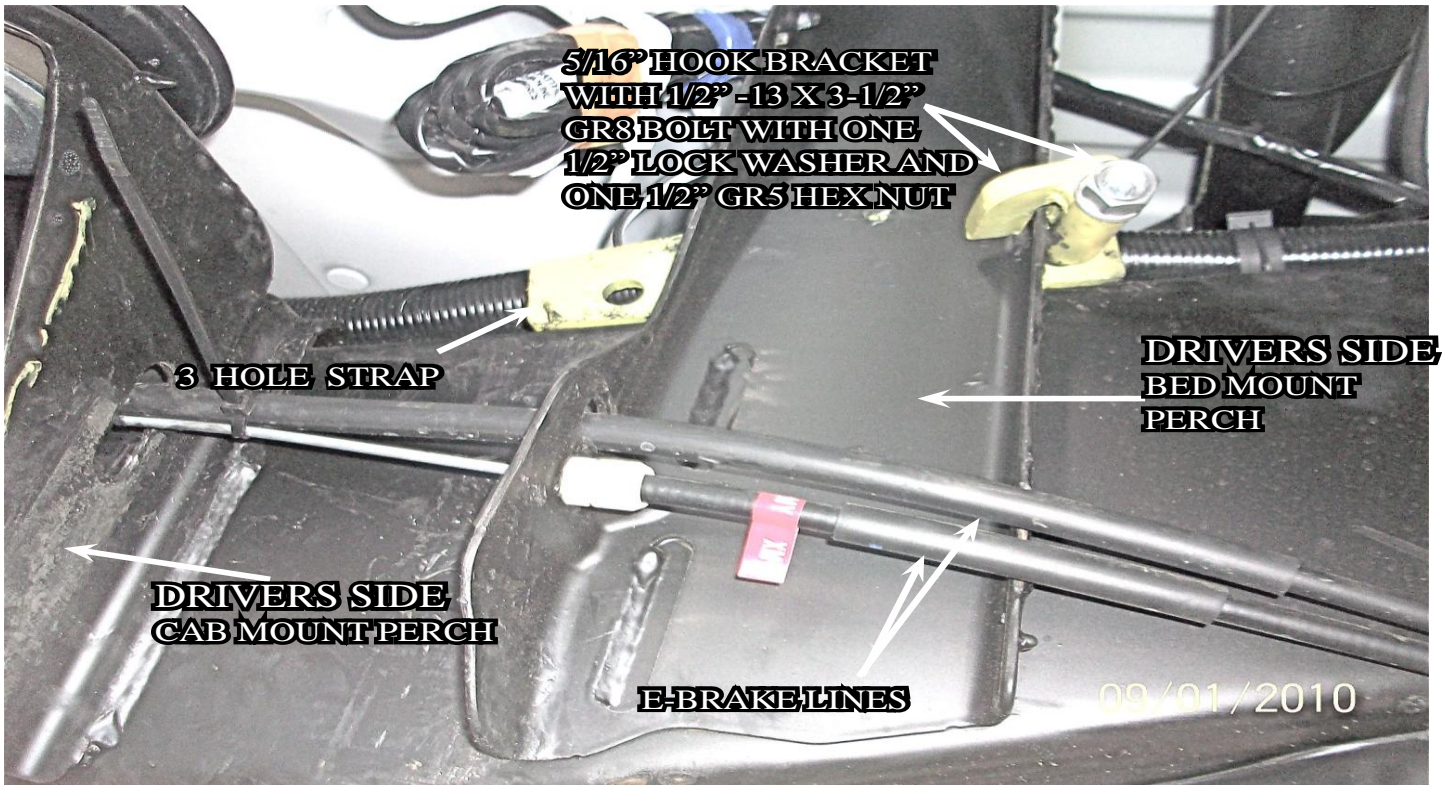

PHOTO D

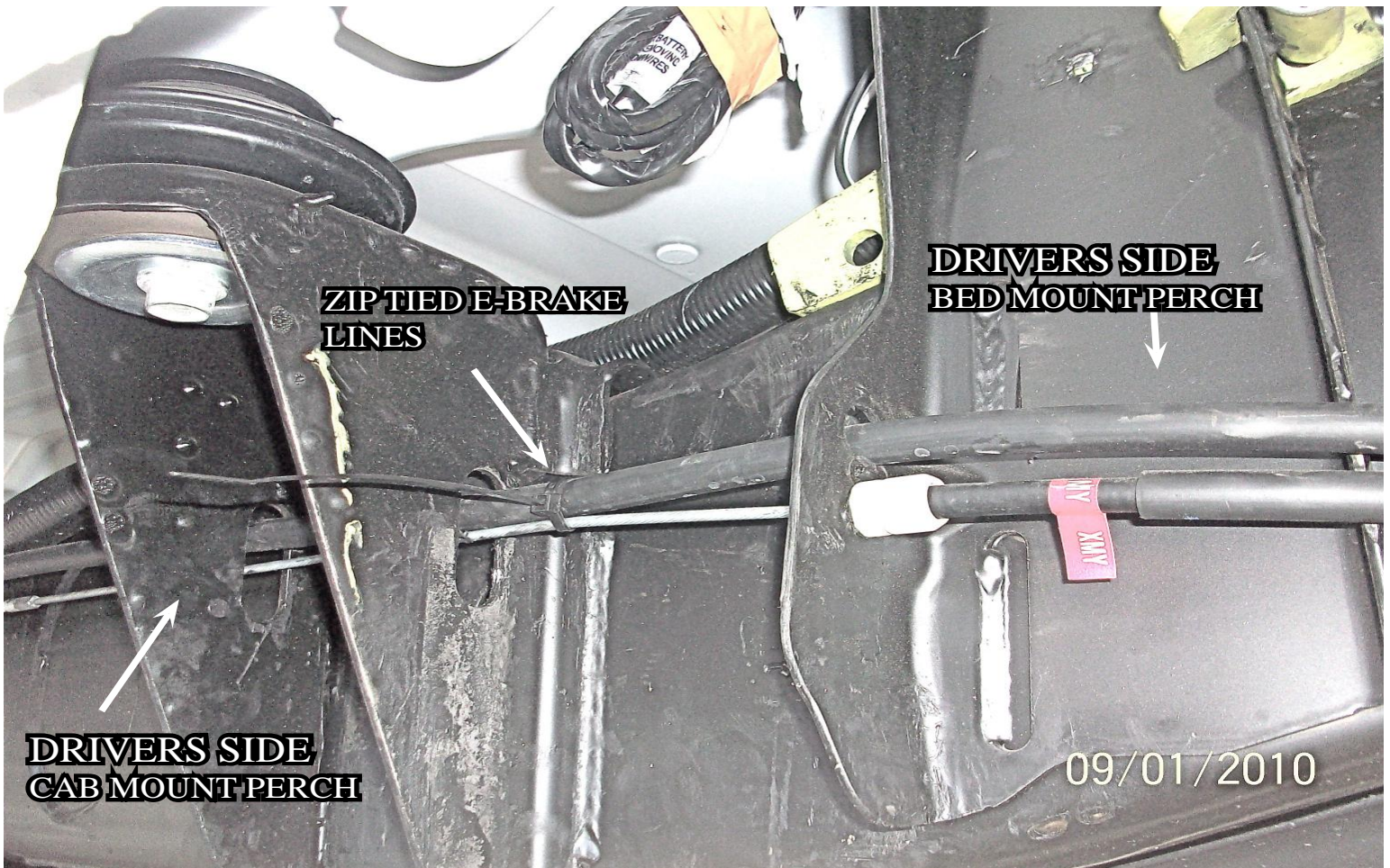

PHOTO E

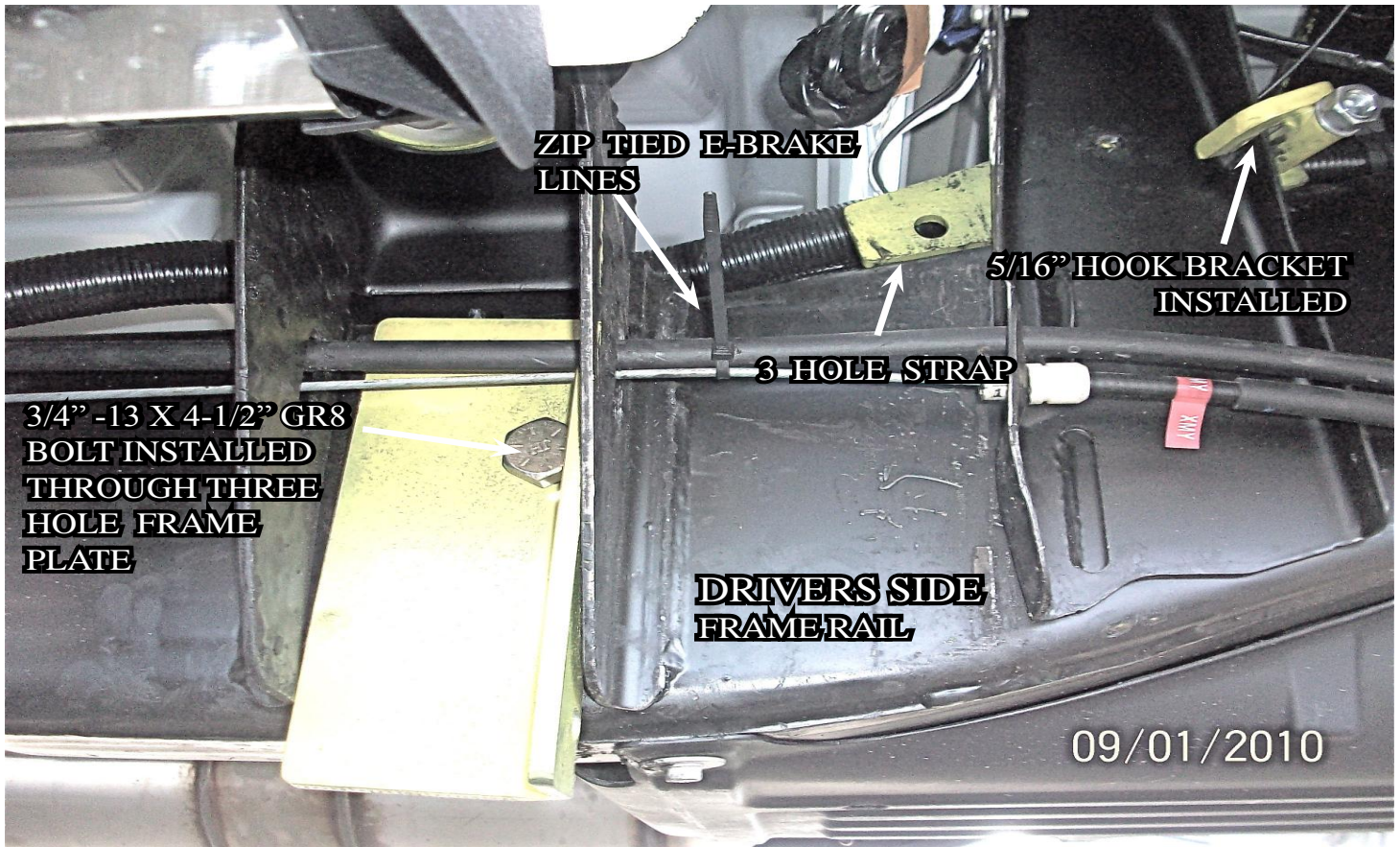

PHOTO F

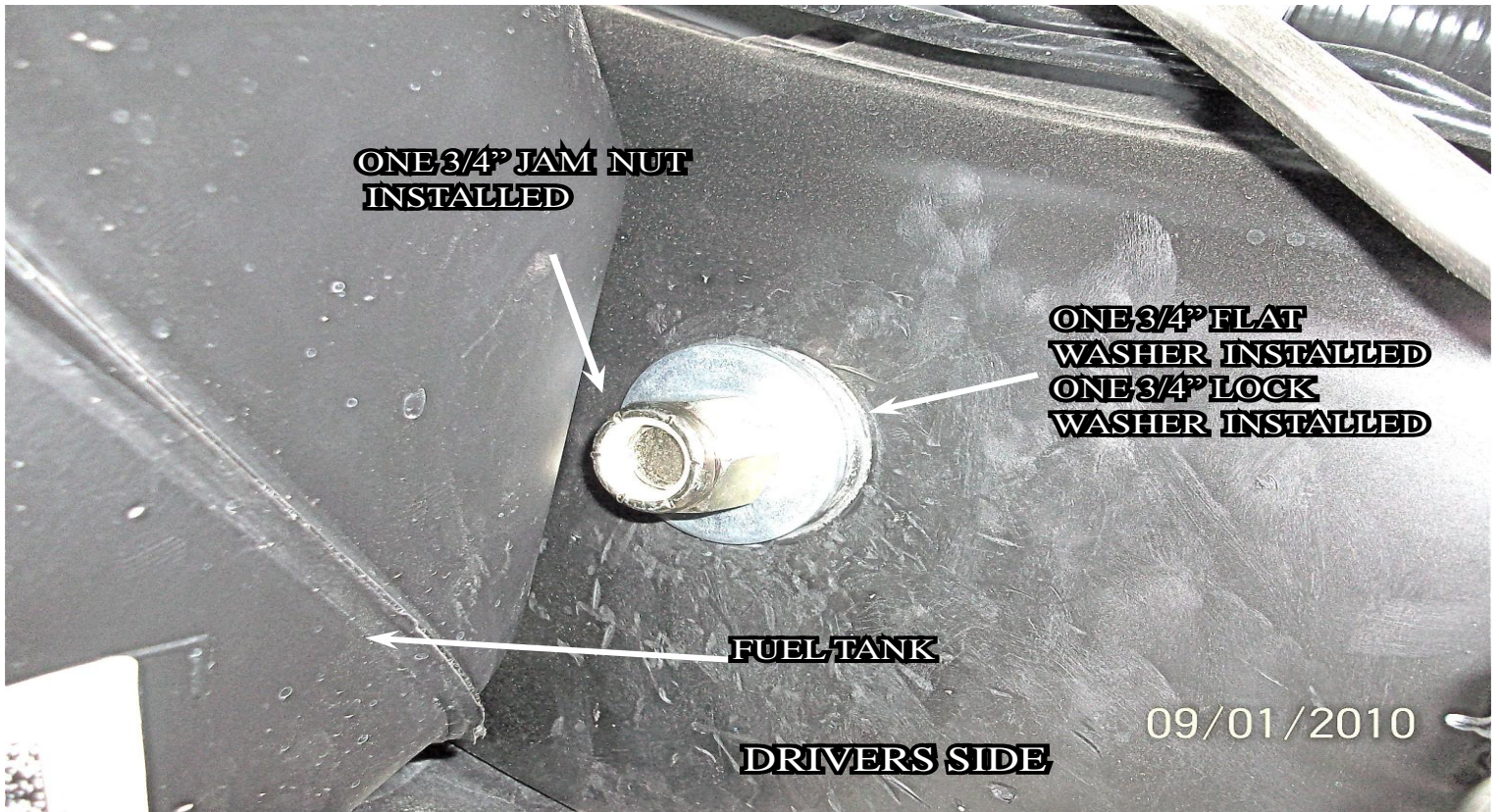

PHOTO G

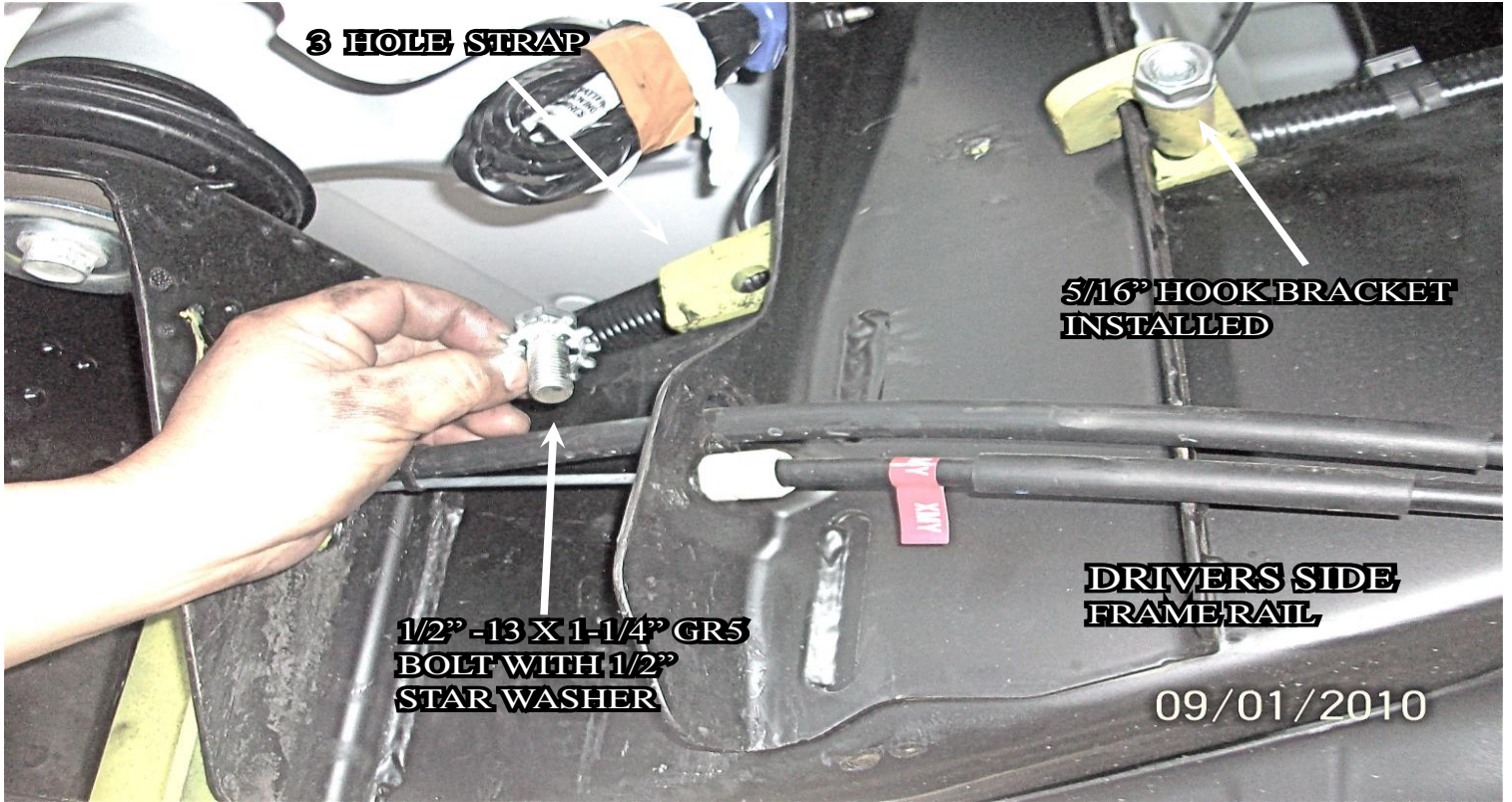

PHOTO H

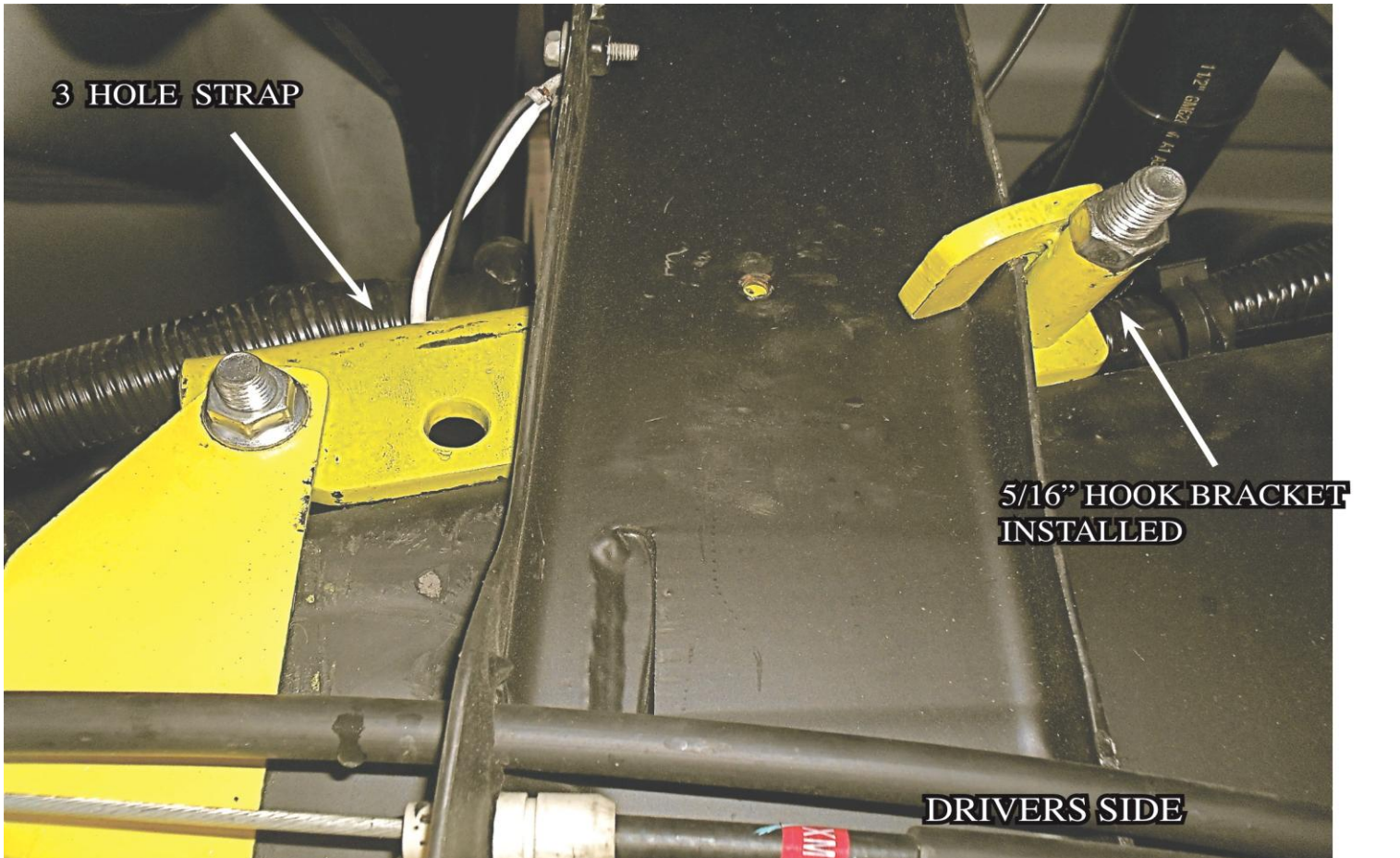

PHOTO I

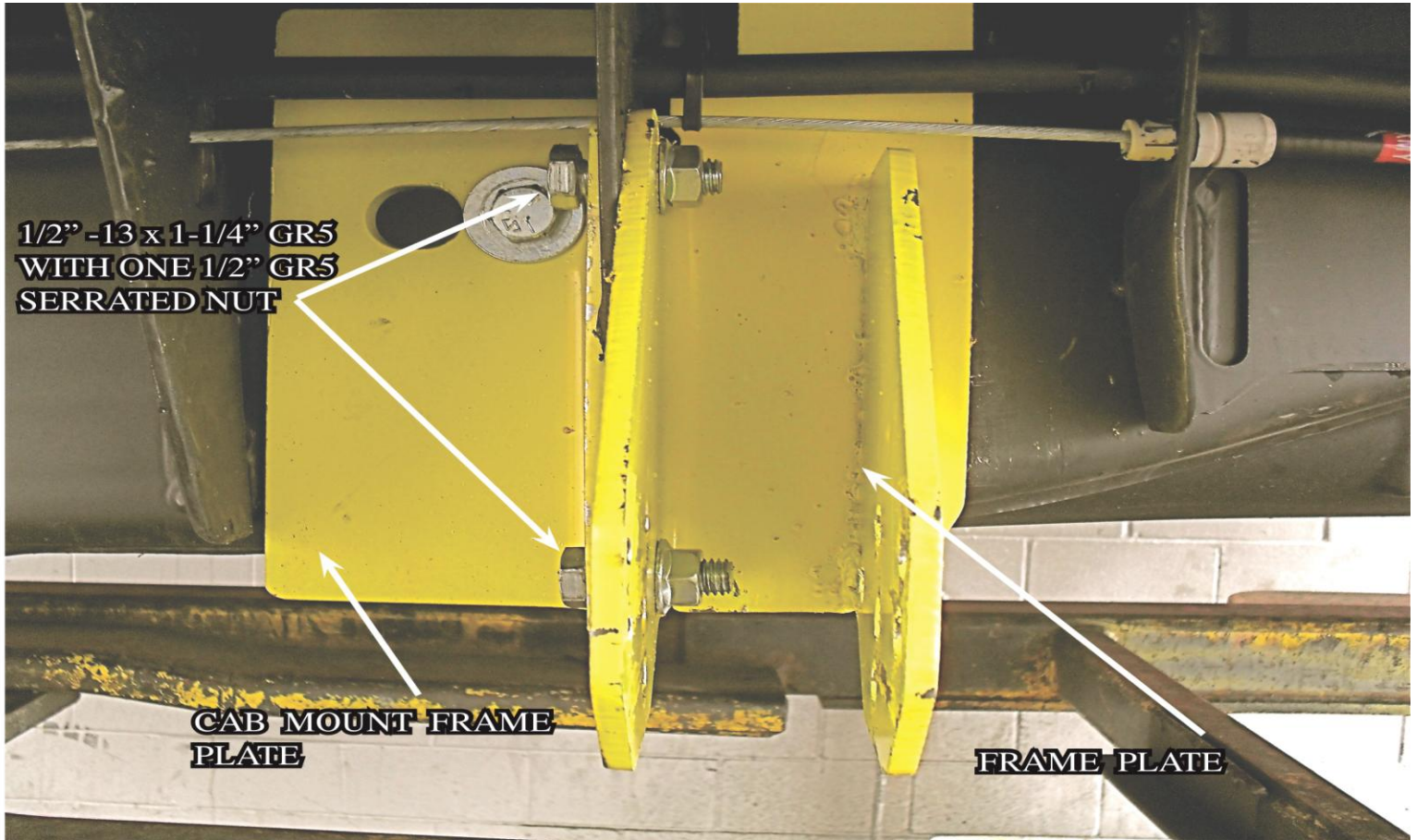

PHOTO J

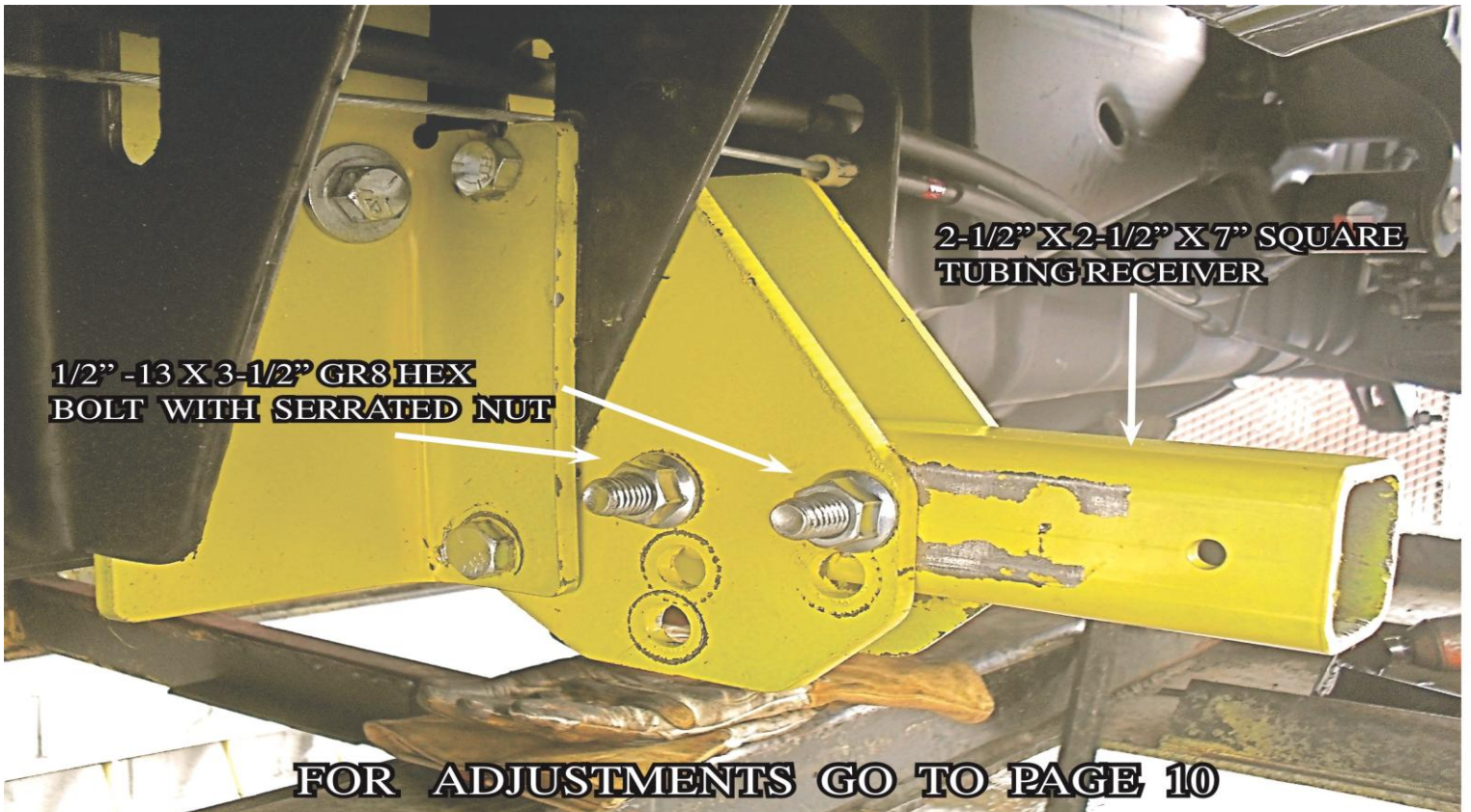

PHOTO K

DRIVERS SIDE



TIGHTEN

ALL GR5 FASTENERS TO 60 FT-LBS(81nm) WITH A TORQUE WRENCH

ALL GR8 FASTENERS TO 60 FT-LBS(81nm) WITH A TORQUE WRENCH

ADJUSTMENTS

The tie down has 4 different setups for angle:

Setup 1

- a. The Receiver bolts to holes 1 & 2
- i. Use a 0.5" x 3.5" bolt through hole 1

Setup 2

- a. The Receiver bolts to holes 1 & 3
- i. Use a 0.5" x 3.5" bolt through hole 1

Setup 3

- a. The Receiver bolts to holes 4 & 5
- i. Use a 0.5" x 1.25" bolt through hole 1

Setup 4

- a. The Receiver bolts to holes 4 & 6
- i. Use a 0.5" x 1.25" bolt through hole 1

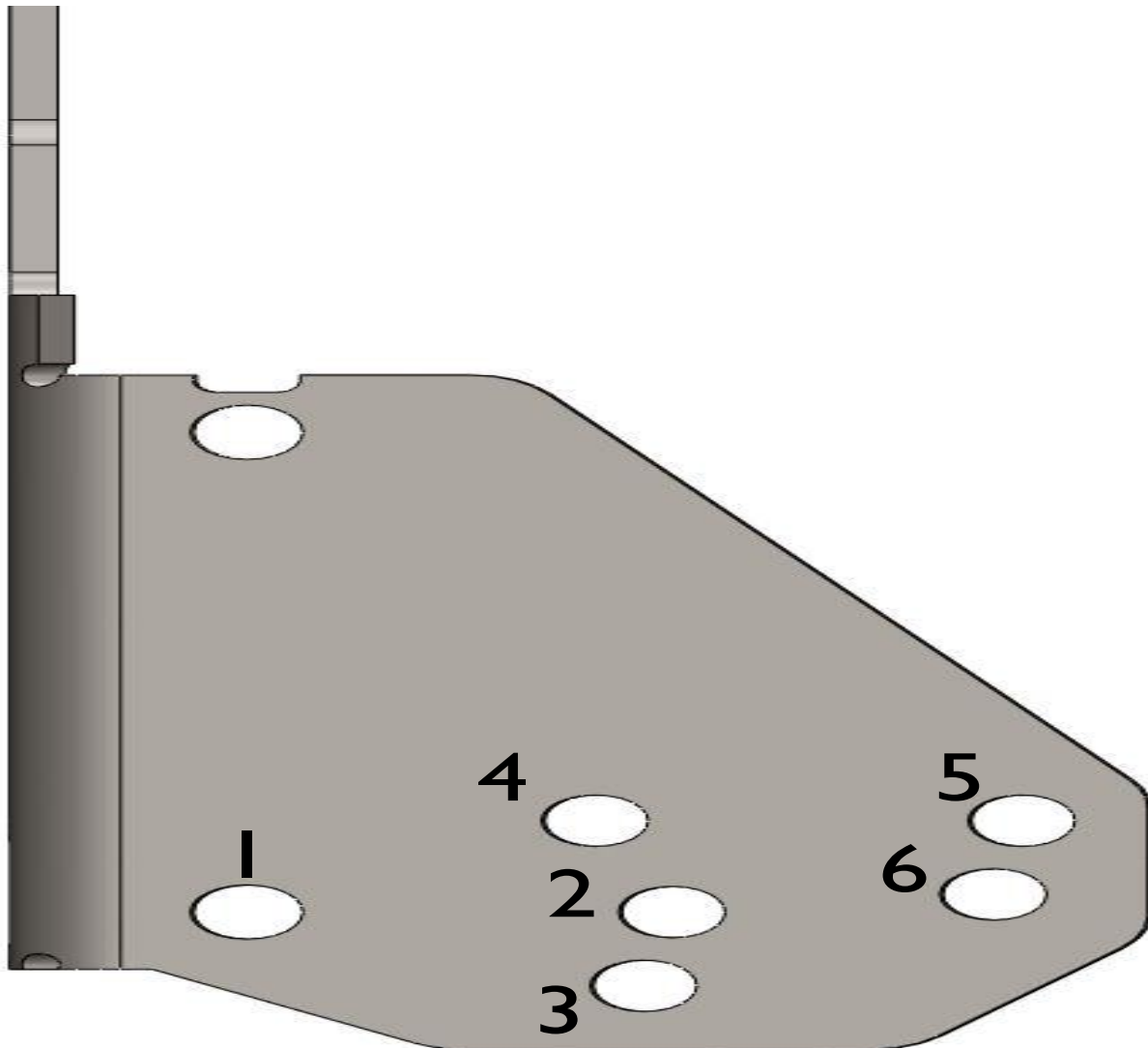

INSTRUCTIONS FOR MAINTENANCE OF POLISHED STAINLESS STEEL PRODUCTS



Torklift utilizes quality grade 304 stainless steel in this product.

304 stainless steel is well known for its anti corrosive properties, however in some environments such as coastal regions or when in contact with some road chemicals, corrosion may occur.

We recommend occasional polishing of our product to maintain its attractive finish. Use an approved stainless steel cleaning/polishing product, which can be purchased from any automotive supplier.

TORKLIFT'S BOLT FISHING GUIDE

Your guide to understanding the installation of our frame mounted tie downs.

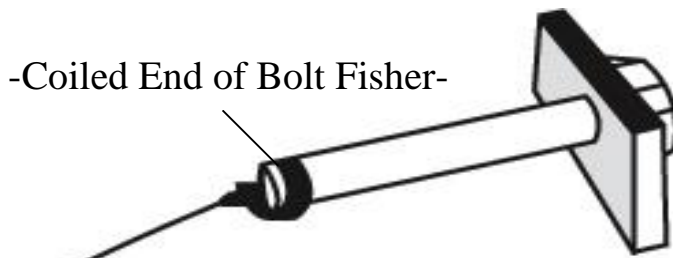

Note: The hardware may vary as to what is being fished along with the bolt. In this instance a 1" X 2" plate washer is being fished along with the hex bolt. Different applications may require fishing through various star washers and flat washers for example.

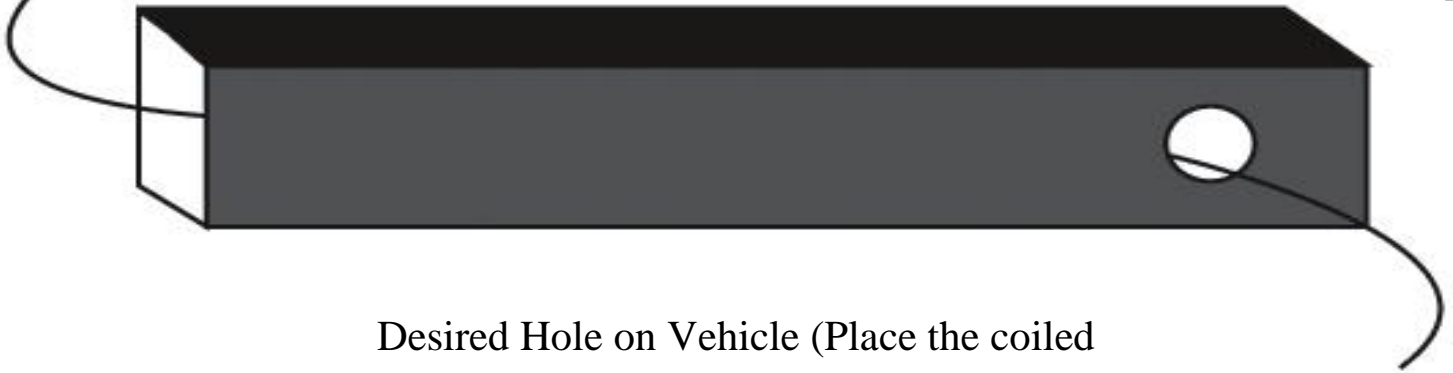

Desired Hole on Vehicle (Place the coiled end of the bolt fisher through this hole).

This side of the Bolt Fisher should come out of a hole where the required hardware (for example 1" X 2" plate washer) can pass through.



This bottom example shows the bolt when it's completely fished through the vehicle. You may find it easier to keep the bolt fisher attached until you get the tie down receiver in place so that the bolt doesn't fall into the vehicle frame.

WARNING: PULLING TOO HARD ON THE BOLT FISHER CAN RESULT IN LOST FASTENERS, OR BROKEN BOLT FISHER.

TIEDOWN INSERT INSTALLATION INSTRUCTIONS

On one end of each of your tie down inserts is a triangular plate referred to by Torklift as a bullet plate. Your tie down inserts should be installed with the shorter side of the bullet plate facing away from each other, i.e.. The shorter side of the front insert should point to the front of the truck and the shorter side of the rear insert should point towards the rear of the truck.

Once installed, attach the TorkLift directional stickers to the face of the bullet plate on the insert as a reminder.

DRIVERS SIDE FRONT



DRIVERS SIDE REAR



IMPORTANT NOTE: *Your tie down inserts are designed to have clearance inside of the receiver. This is to account for road debris, as well as aid in installation and removal. Some rattle may be expected if the inserts are left installed while not under load from the camper.*

RECOMMENDED TRUCK CAMPER

INSTALLATION INSTRUCTIONS

When securing any heavy load (especially a camper) in your truck bed, your front tie down points should pull the load forward as much as possible. Some camper anchor points may differ with different manufacturers, as well as the camper jack mounting locations. Your Torklift tie down inserts has offset triangular brackets to increase the angle of pull. These are designed to be used in the front facing forward, and the rear facing rearward but can be used in either front or rear. These recommendations are to be considered and followed as a basic rule of thumb. Obviously there will be some applications where this may not be possible. At a minimum, if opposite pull of both front and rear tie downs cannot be achieved for whatever reason, you should have at least a forward pull at the front or rear location.

If your camper does not come with Rubber Bumpers on the front lower portion of the camper, installing Rubber Bumpers (Torklift has Rubber Bumpers available Part A7001) or using a block of wood such as a 2 x 4 in the bed, will prevent the camper from damaging the front bulk head of the truck bed.

Minor movement (or settling) can occur in some incidental harsh driving conditions (on or off road). A rubber bed mat is not a requirement to maintain the lifetime warranty on a Torklift system, but a strong recommendation simply as a safety precaution to protect the truck bed, the bottom of the camper and to give the camper additional support.

TORKLIFT DOES NOT RECOMMEND: Installing your truck camper in your truck on top of a drop in plastic bed liner!!! The drop in plastic bed liners can slide on top of the truck bed surface, and the camper can slide on top of the slick surface of the bed liner. The liner can also act as a spring causing a trampoline effect increasing vertical truck camper movement, independent of the vehicle, possibly resulting in truck bed, and camper damage!

INSTRUCTIONS FOR FINISH MAINTENANCE

OF TORKLIFT PRODUCTS

POWDER COATED STEEL:

To keep your Torklift products looking good follow these guidelines. All steel powder coated Torklift products are sandblasted for maximum adhesion and use a high quality industrial urethane based powder coat. Due to the extreme, harsh, undercar environment that your Torklift products live in, (consistently sprayed with corrosive road chemicals such as salt, and road debris), Torklift does not warranty the powder coated finish.

To minimize corrosion from these factors on powder coated steel products, Torklift recommends regularly cleaning and inspecting the powder-coated surface and touching up any affected areas with enamel or urethane based aerosol paint product. If there are any areas of surface rust, there are also aerosol spray rust converters available on the market that can be used as a preparation to touch-up paint application. These finish maintenance products are available at any automotive parts supplier.

POLISHED STAINLESS STEEL:

Torklift utilizes quality grade 304 stainless steel in our stainless steel polished products. 304 stainless steel is well known for its anti-corrosive properties. However, in some environments such as coastal regions or when coming in contact with some road chemicals, corrosion may occur.

For a quick clean simply use WD40 and a cloth rag. We also recommend occasional polishing of our polished stainless products to maintain their attractive finish. Use an approved stainless steel chrome or aluminum mag wheel polish cleaning product, which can be purchased from any automotive parts supplier.

Torklift International Limited Lifetime Warranty Information

322 Railroad Ave North, Kent, WA 98032

Torklift will require proof of purchase to register, with pictures of any defective product before issuing a replacement. Torklift will not register any product without proof of purchase, which can be faxed, scanned, emailed, or mailed to the information provided below. Torklift warrants its hitches, custom hitch receivers, frame mounted tie downs, turnbuckles, and accessories (excluding wire harnesses which carry a 90 day warranty) from date of purchase against defects in material and workmanship under normal use and service for the ownership life of the original consumer purchaser. **ALL COMMERCIAL APPLICATIONS ARE WARRANTED FOR A PERIOD OF 90 DAYS FROM THE DATE OF INSTALLATION/SERVICE.** Torklift will replace **FREE OF CHARGE** any part, which proves defective in material or workmanship when presented to Torklift, **TRANSPORTATION CHARGES PREPAID** by purchaser, at the address above. **THIS WARRANTY IS LIMITED TO DEFECTIVE PARTS REPLACEMENT ONLY. LABOR CHARGES AND/OR DAMAGE INCURRED IN INSTALLATION OR REPLACEMENT, AS WELL AS INCIDENTAL AND CONSEQUENTIAL DAMAGES CONNECTED THEREWITH ARE EXCLUDED.** This warranty does not include the finish or paint on our products. Rusting, cracking or peeling of the finish is also excluded. Some states do not allow the exclusion or limitation of incidental or consequential damages, so the above limitation or exclusion may not apply to you. Any damage to Torklift products as a result of misuse, abuse, neglect, accident, improper installation or any use violation of instructions furnished by Torklift or **WHEN USED IN ANY COMMERCIAL APPLICATION WILL VOID THE WARRANTY.** This warranty gives you specific legal rights, and you may also have rights, which vary from state to state. With warranty service, you may be able to go to a small claims court, a state court or a federal district court.



OVER 35 YEARS OF INNOVATION, QUALITY, SAFETY.

322 Railroad Ave North, Kent, WA 98032

Phone (800) 246-8132 Fax (253) 854-8003

or visit our website: www.TorkLift.com

Dear Valued Customer,

Thank you for making TorkLift your choice for truck, camper packages and accessories for your vehicle. By choosing TorkLift products, you have chosen a company that has been serving the RV industry for nearly 40 years and whose name has become synonymous with strength, quality and advanced design and installation.

Please take a few moments of your time to complete the Product Registration Warranty Card on the next page. When registering your newly purchased TorkLift products, you can be assured that your contact information is secure and that you and your product are getting the attention and respect that you deserve.

Thank you again for choosing TorkLift quality products.

**Register for your lifetime warranty and receive a free Torklift
International gift.**

To Fax: Send copies of the questionnaire, warranty card and receipt to
253-854-8003

To E-mail: Send copies of the questionnaire, warranty card and receipt to
warranty@torklift.com

To Mail: Send to Torklift International 322 Railroad Ave North, Kent, WA 98032

Frame Mounted Tie Downs

Leading the camper tie down industry in strength, quality, advanced design and installation. TorkLift TRUE frame mounted tie downs are far superior to all tie down systems available.



The TorkLift system is unique in its design and is patented. Four independent tie down points (with no belly or crossbar) working much like your receiver type trailer hitch as the inserts are removable allowing the system to be virtually undetectable when not in use.

They are designed for each make and model to fit tight to the frame so as not to compromise ground clearance. TorkLift tie downs are not universal 'one size fits all' therefore all the problems with correct fit for each particular application have been eliminated.

Original SuperHitch & SuperHitch Magnum

High strength extended hitch system engineered for safely towing all types of trailers behind your truck and camper. With a max towing capacity of 14,000 lbs.(6350kg) with an extension*, (17,000 lbs.(7711kg) to 20,000 lbs.(9071kg) without*) the Original SuperHitch and SuperHitch Magnum are rated the strongest in the industry.



CONTACT YOUR LOCAL DEALER FOR MORE DETAILS

*Weight capacity varies depending on the SuperHitch and SuperTruss extension setup.



TORKLIFT

INTERNATIONAL

OVER 35 YEARS OF INNOVATION, QUALITY, SAFETY.

OFFICIAL WARRANTY REGISTRATION CARD

PLEASE FILL OUT THIS FORM COMPLETELY AND RETURN TO TORKLIFT WITHIN 30 DAYS OF PURCHASE ACCOMPANIED BY A COPY OF YOUR ORIGINAL RECEIPT

TODAY'S DATE: _____

1. PART(S) PURCHASED

PART#: _____ PART#: _____
PART#: _____ PART#: _____

2. PURCHASER INFORMATION

NAME: _____

ADDRESS: _____

CITY: _____ STATE: _____ ZIP / POSTAL CODE: _____

PHONE: (_____) - _____ EMAIL: _____

3. TRUCK INFORMATION

YEAR: _____ MAKE: _____

MODEL: _____ BED LENGTH: _____

4. CAMPER INFORMATION

YEAR: _____ MAKE: _____ MODEL: _____

5. DEALER INFORMATION

PURCHASED FROM: _____

ADDRESS: _____

CITY: _____ STATE: _____ ZIP / POSTAL: _____

INSTALLED BY: OWNER ABOVE DEALER ANOTHER DEALER

IF ANOTHER DEALER, WHO: _____