



ecoHITCH -Designed Specifically For Your **Green Vehicle**

Installation

Application Fits

2014 to 2016 Mini Cooper Hardtop/Convertible
X7290

NO S MODELS

1.25" EcoHitch Stealth

100 lbs Tongue Weight/ 1,000 lbs. Towing Weight

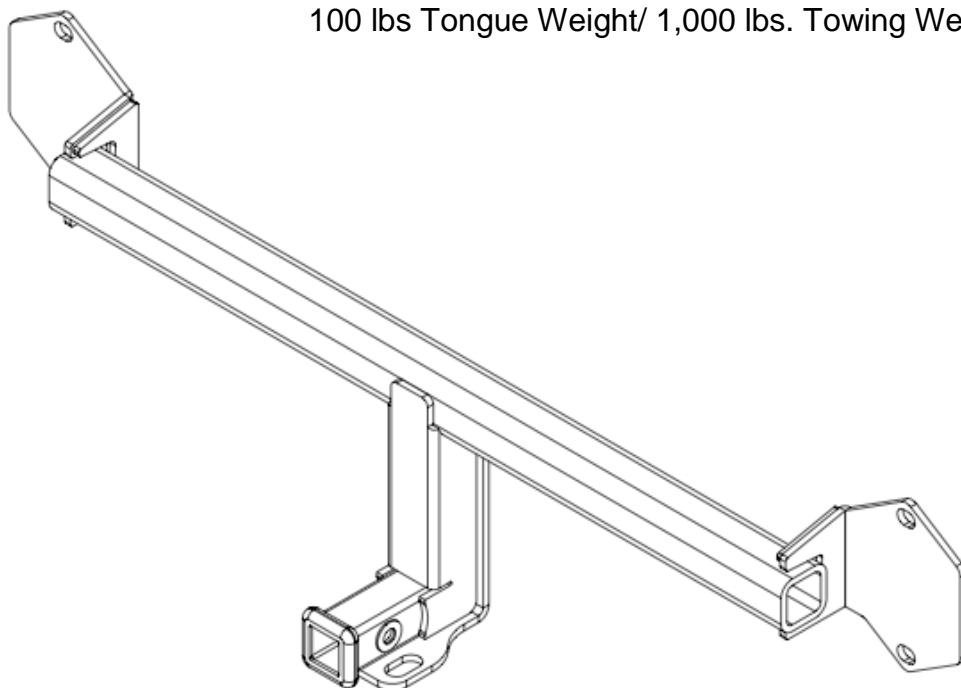

Torklift Central
315 Central Ave N
Kent, WA 98032
253-854-1832
www.torkliftcentral.com
support@torkliftcentral.com

Stay Connected



torkliftcentral



torkliftcentral



tlcentral



torklift central



torklift central



QTY	Fastener
2	11" Zip Ties
1	12" Trim-Lok

READ THESE INSTRUCTIONS THOROUGHLY AND ACCOUNT FOR ALL HARDWARE LISTED BEFORE BEGINNING INSTALLATION!

Step 1. Raise rear of vehicle off of ground and place on ramps or suitable jack stands.

Step 2. Remove the (7) screws from the underside of the bumper designated by the arrows in Figures [1], [2], & [3]. Loosen but do not completely remove the (1) screw located in each of the wheel wells on the rearward wall shown in Figure [4].

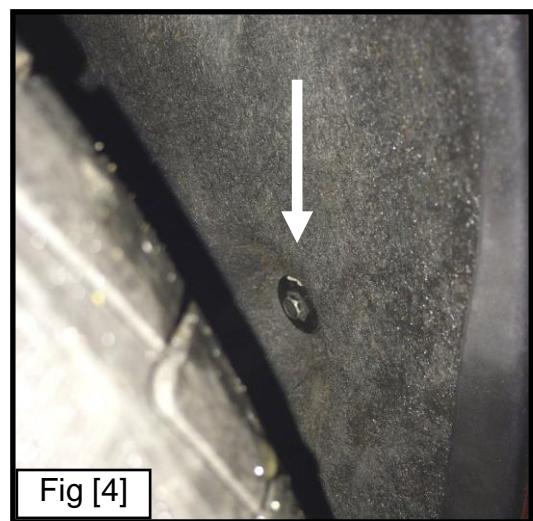
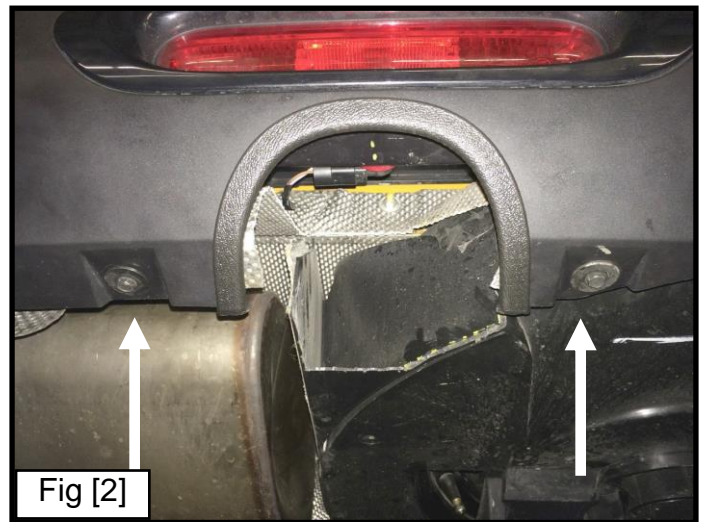
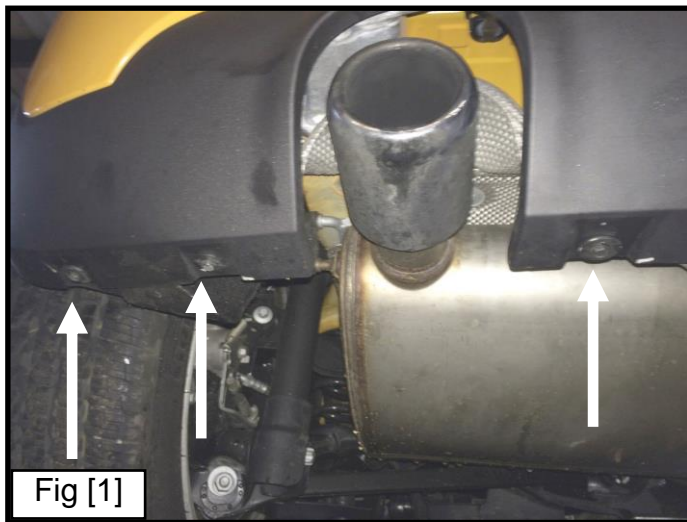

Step 3. Using a plastic flathead tool, carefully pry off the chrome trim surrounding the tail light assemblies. Repeat on opposite side of vehicle. See Figure [5] & [6]. Remove the (2) screws shown in Figure [6] from each of the tail light assemblies.



Fig [5]



Fig [6]

Step 4. Remove the tail light assembly access doors located on the driver and passenger side in the trunk compartment. Disconnect the tail light assembly wiring harness on both the driver and passenger side. See Figure [7] & [8].

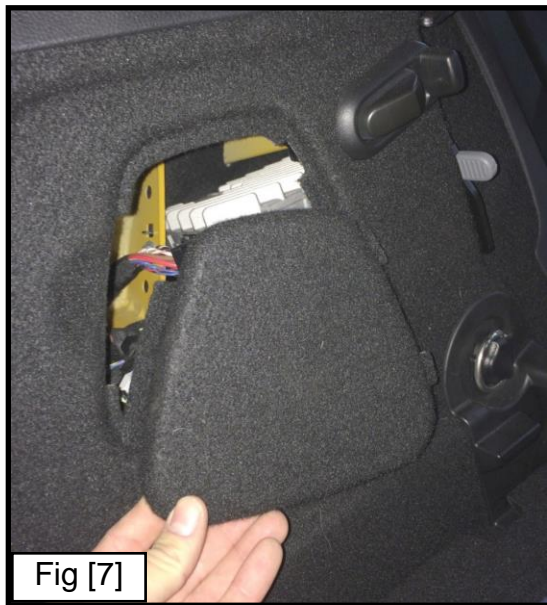

Fig [7]

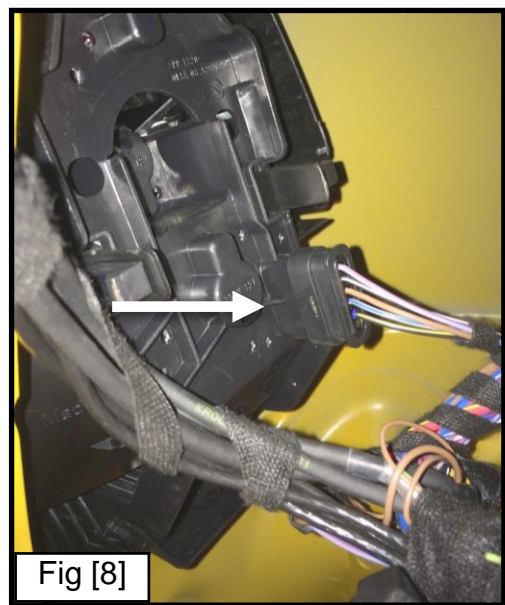
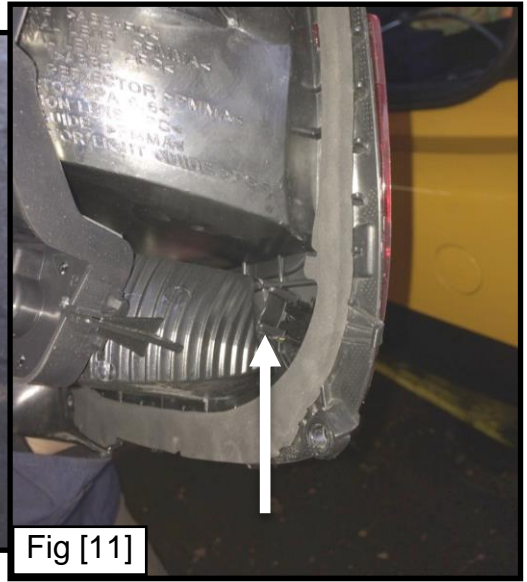
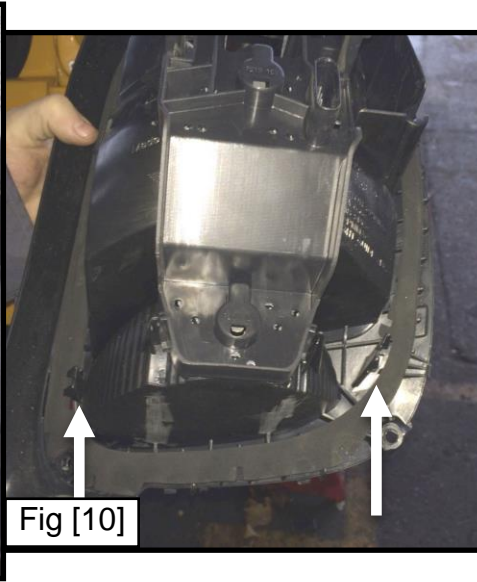

Fig [8]

Step 5. Reach your hand inside the tail light assembly access door where you will find two tabs on each tail light assembly. Gently disconnect each tab by depressing inward towards the center of the light. Repeat on opposite side. See Figure [9], [10], [11].



Step 6. Remove the (1) hex bolt located under the bumper near the fog light. See Figure [12].



Step 7. Gently pull on fender flares starting at the rearward end, unsnapping as you go. Once pulled back you will notice a backup sensor attached. Gently disconnect the sensor harness. Repeat on opposite side of vehicle. See Figure [13].

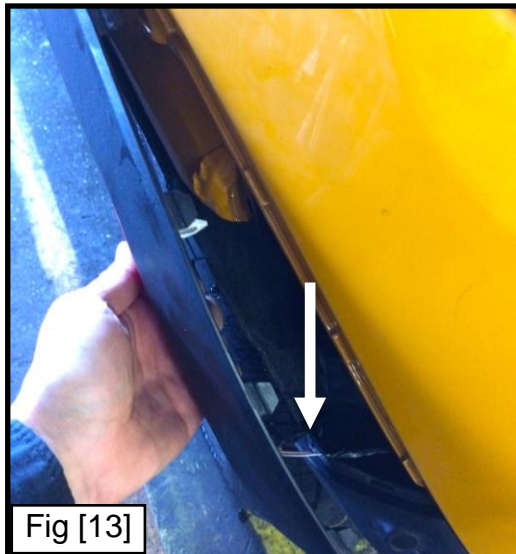

Step 8. Remove the (2) screws shown in Figure [14] from the driver and passenger side of the bumper.



Step 9. Disconnect the bumper from the vehicle starting at the driver side. Use a flathead tool to release tabs located at the tail light assembly area. Continue removing the bumper until you have reached the passenger side. See Figure [15].
WARNING: Do not completely remove the bumper to avoid wire damage!

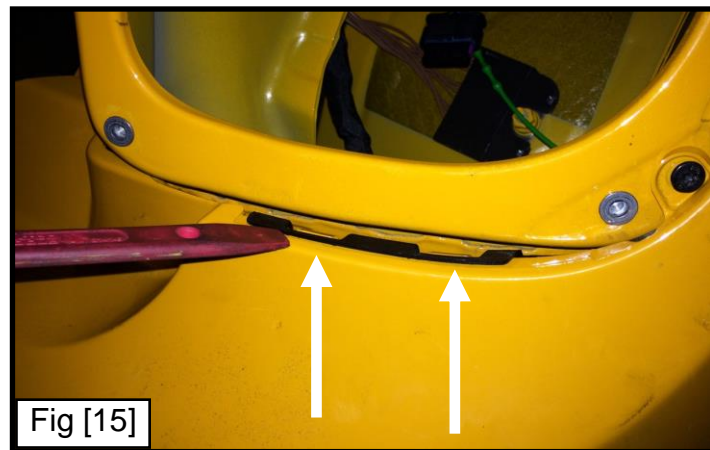

Step 10. With the bumper detached, disconnect the back-up sensor wire harness and fog light wire harness to completely remove the bumper. See Figure [16].

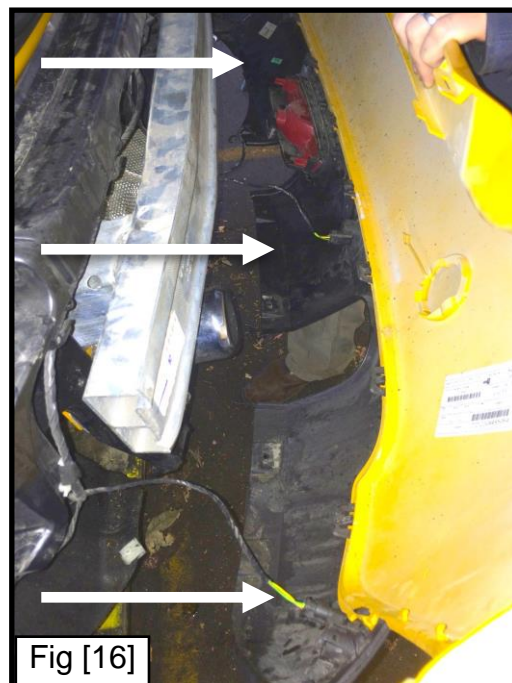

Step 11. Unbolt the impact bar by removing the (4) factory nuts. See Figure [17].



Step 12. Unhook the backup sensor wire harness from the plastic holders on the driver and passenger sides. Trim the plastic holders as shown in Figure [18] & [19].
Note: Temporarily tie the wire harness away from the plastic holders while trimming.

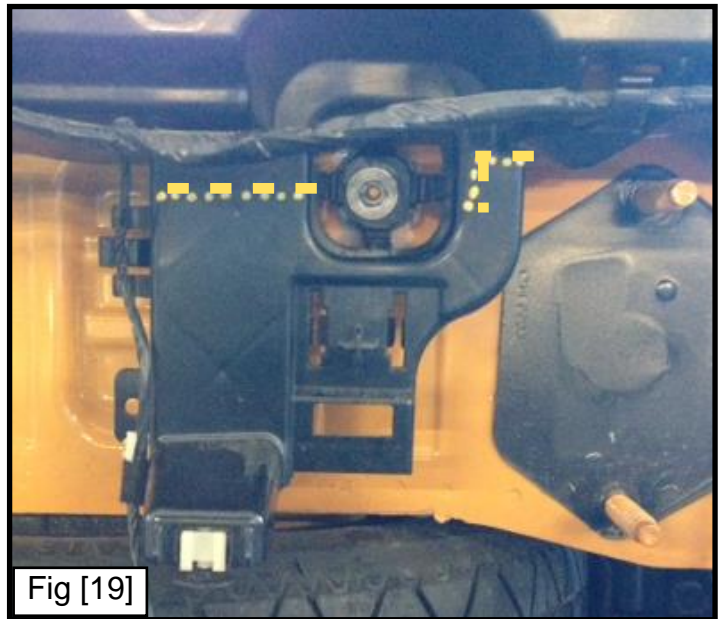
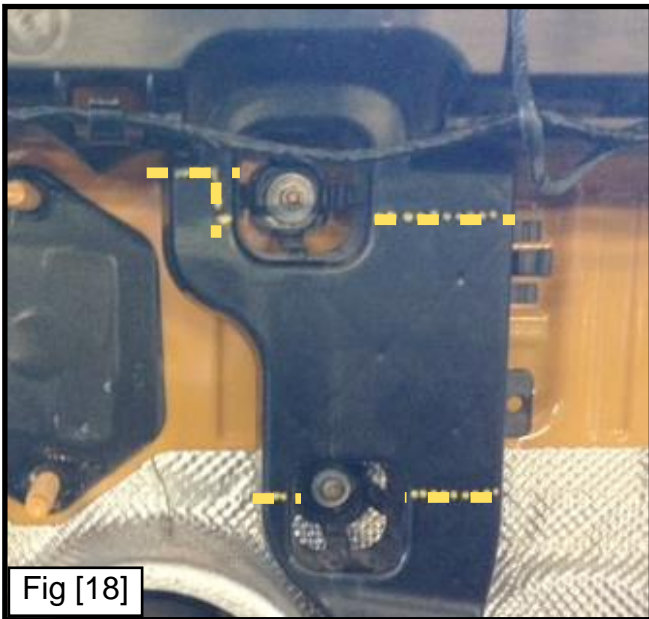

Step 13. Remove and discard the plastic vent bracket shown in Figure [20].



Step 14. Trim the exhaust heat shield at the center of the vehicle where the EcoHitch will sit. You will notice creases in the heat shield that will make it easy to follow the cutting pattern. Trim the plastic tire pan located behind the exhaust heat shield to continue allowing space for the EcoHitch. See Figure [21], [22], [23].

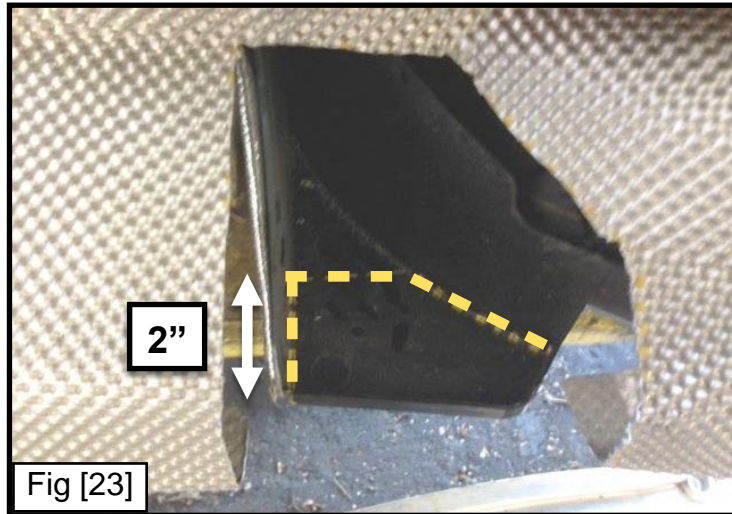
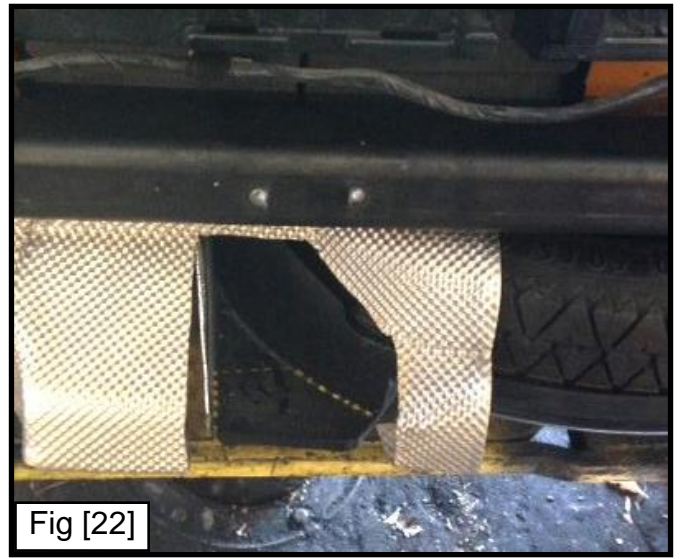
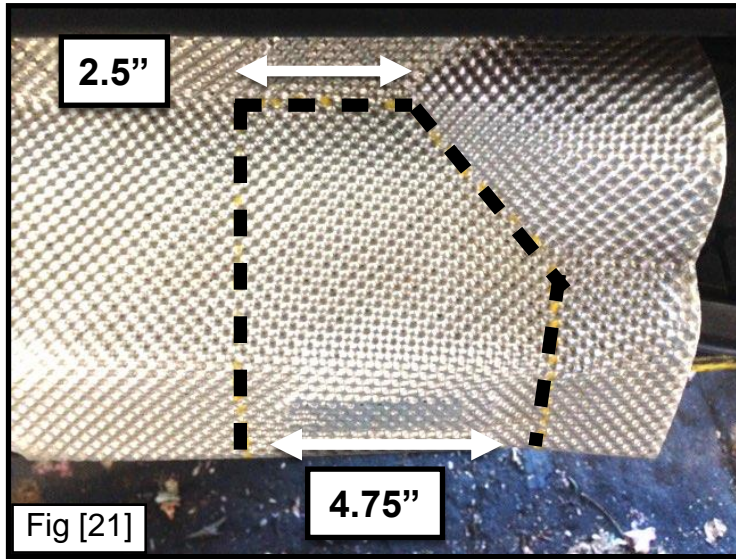

Step 15. Place the hitch onto the impact bar stud bolts, then replace the impact bar over the hitch and secure with the factory nuts. Torque the impact bar nuts to 50 ft-lbs. Secure the wire harness to the cross tube of the hitch with the supplied zip ties. See Figure [24].



Step 16. At the center of the bumper fascia, mark a 3-1/2" x 5" square for trimming. Use an air saw or utility knife to cut out this square and then line the edges with the supplied Trim-Lok. Cut any excess Trim-Lok for a cleaner fit. See Figure [25].

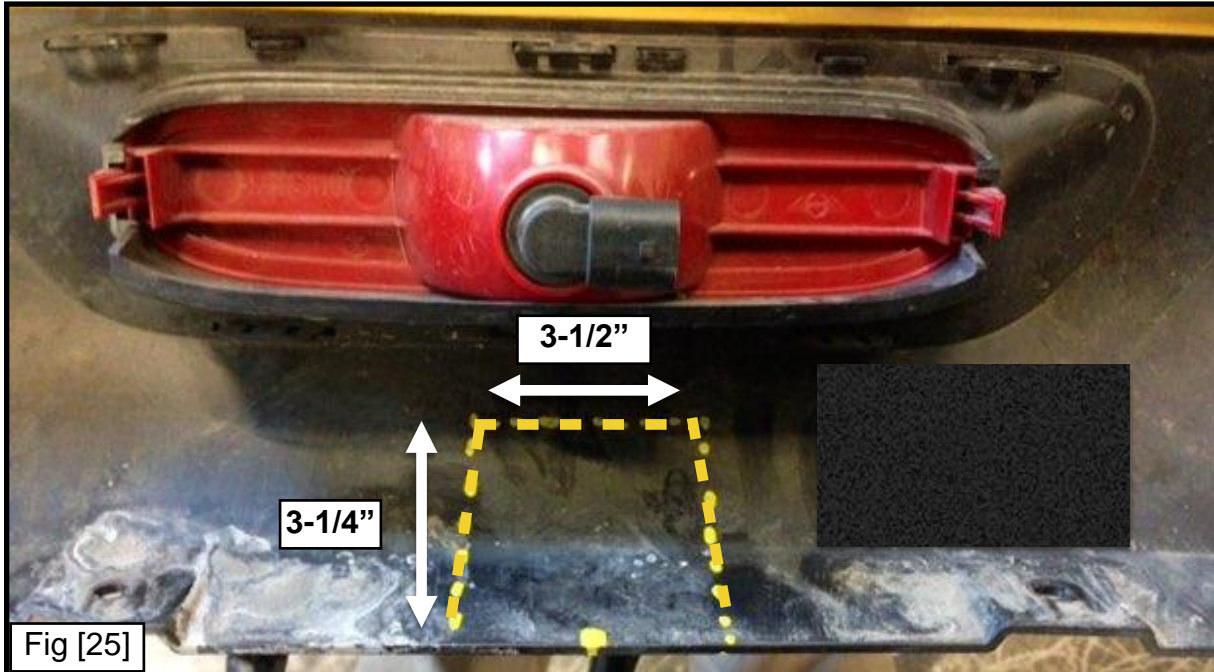

Step 17. Reinstall bumper fascia following these steps in reverse starting at Step 10.

Congratulations on the completed installation of the Mini Cooper Stealth EcoHitch! It is designed with a lifetime warranty for a lifetime of enjoyment. If you have any questions or suggestions please contact our tech support at support@torkliftcentral.com or by phone at (253)-854-1832.

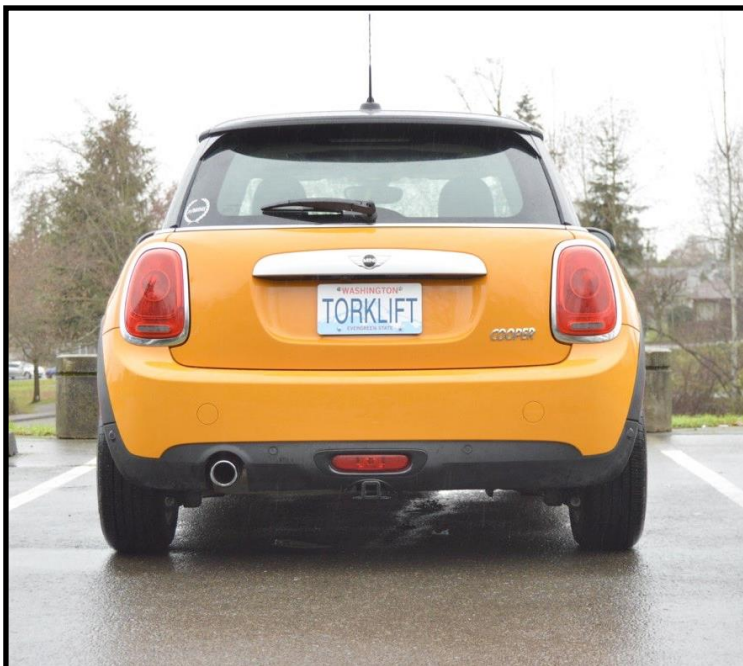

WARRANTY/DISCLAIMER INFORMATION

Torklift Central requires proof of purchase for warranty claim registration, with pictures of any defective product before issuing a replacement. Torklift will not accept claims on any product without proof of purchase, which can be faxed, scanned, emailed or mailed to the information provided below. Torklift Central warrants its hitches, custom hitch receivers and accessories (excluding electrical wire harnesses which carry a warranty from their specified manufacturer) from date of purchase against defects in material and workmanship under normal use and service for the ownership life of the original consumer purchaser. Torklift Central will replace free of charge any part that proves defective in material or workmanship when presented to Torklift Central, transportation charges prepaid by purchaser, at the address below. **This warranty is limited to defective parts replacement only. Labor charges and/or damage incurred in installation or replacement, as well as incidental and consequential damages connected therewith are excluded.** This warranty does not include normal wear and tear or the finish and paint. Rusting, cracking or peeling of the finish is also excluded. Some states do not allow the exclusion or limitation of incidental or consequential damages, so the above limitation or exclusion may not apply to you. Any damage to Torklift Central products as a result of misuse, abuse, neglect, accident, improper installation or any use violative of instructions furnished by Torklift Central will void the warranty. This warranty gives you specific legal rights and you may also have rights, which vary from state to state. With warranty service, you may be able to go to a small claims court, a state court or a federal district court.

Although Torklift Central trailer hitches are both tested and rated for towing within the specific capacity label found on each trailer hitch. Torklift Central assumes no liability for vehicle manufacturers warranty due to the use of a Torklift Central trailer hitch being used for towing behind any vehicle or using the trailer hitch in a manner that it was not designed for. Although this specific trailer hitch has a load rating, which includes trailer tongue weight, and a trailer weight carrying capacity, Torklift Central is not responsible for the voiding of any warranty on any vehicle due to factory towing limitations. All vehicle warranties are the sole property and responsibility of the owner of the vehicle that the Torklift Central trailer hitch is installed upon. Torklift Central does not endorse towing behind any vehicle if the vehicles manufacturer states that towing is not recommended. Check your vehicle's owner's manual for the proper tow rating of your vehicle.

ADDRESS: 315 Central Ave N. Kent, WA 98032

WARNING Your vehicle may have a lower tow rating than this trailer hitch. If your vehicle's tow rating is less than the rated towing capacity on your Torklift Central trailer hitch, your trailer hitch capacity is limited to your vehicle's factory rated towing capacity.

FOR EXAMPLE: the label on your Torklift Central trailer hitch states it's capacity is rated for 500 pounds tongue weight and 5,000 pounds towing weight. However your vehicle's factory rated towing capacity is limited to only 350 pounds tongue weight and 3,500 pounds towing weight. In this example your maximum towing capacity of your Torklift Central trailer hitch is limited to 350 pounds tongue weight and 3,500 pounds towing weight as stated by your vehicle's maximum factory tow rating.

DANGER Never exceed your vehicle's manufacturer's recommended towing capacity which may be a lower rating than this trailer hitch

Unsure of your tow rating? Download our towing app from the app store to find your vehicles tow