



B&W Trailer Hitches
 1216 Hawaii Road / PO Box 186
 Humboldt, KS 66748
 800.248.6564
 620.473.3664
 Fax:620.473.3766

NOTE: *We recommend reading instructions before beginning the installation.*
WARNING: *The tow vehicle's towing capacities should under NO circumstances be exceeded.*

Turnoverball™ Gooseneck Hitch Installation Instructions

Model 1394R

Call or Email us for Installation Support
hitches@turnoverball.com
www.turnoverball.com

Dodge (1994 -2001)
 1/2 Ton, Short & Long Bed
Dodge (1994 -2002)
 3/4 & 1 Ton, Short & Long Bed

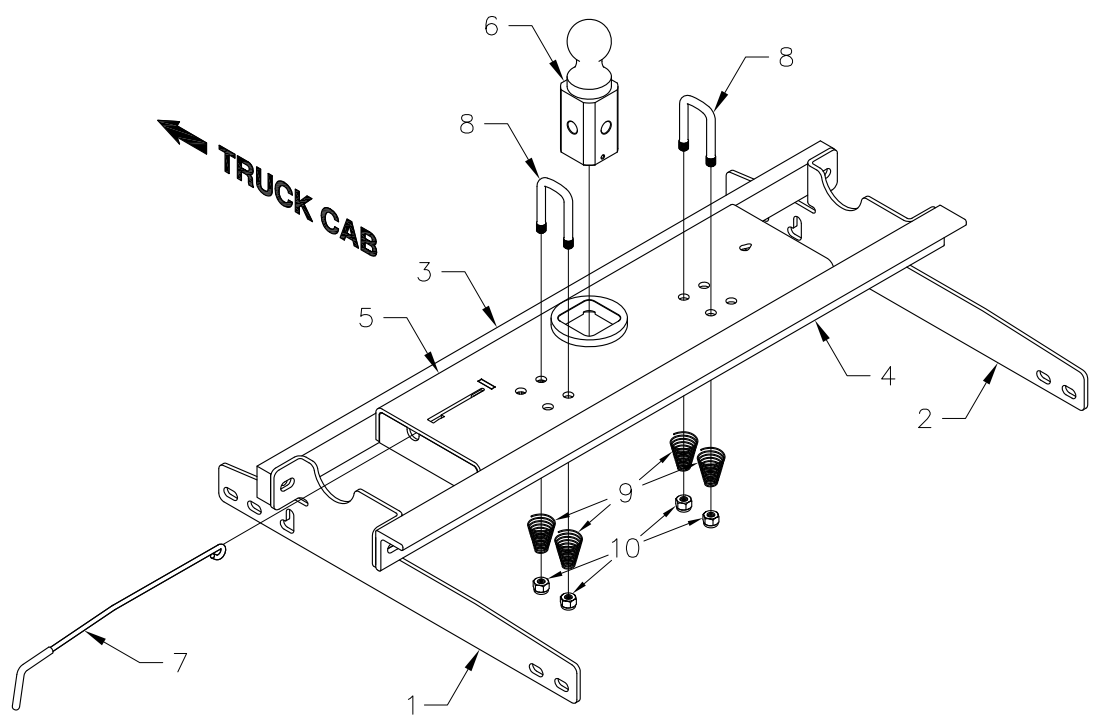

Mounting Kit Box (GNRM1394)		
ITEM	DESCRIPTION	QTY
1	Driver Side Plate	1
2	Passenger Side plate	1
3	Front Crossmember	1
4	Rear Crossmember	1

Mounting Kit Bolt Bag		
	1/2" X 1-1/2" Cap Screw	15
	1/2" Flat Washer	19
	1/2" Lock Washer	15
	1/2" Finish Nut	9

Center Box (GNRC900)		
ITEM	DESCRIPTION	QTY
5	Center Section	1
6	2-5/16" Ball	1
7	Latch pin Handle	1

Safety Chain Kit Bolt Bag		
8	1/2" U-Bolt	2
9	Conical Springs	4
10	1/2" Lock Nut	4
	5/16" X 3/4" Carriage Bolt	1
	5/16" X 3/4" Cap Screw	1
	5/16" Lock Nut	1

NOTICE: This product was designed to fit vehicles in their original, "as manufactured" condition. Compatibility with vehicles having replacement parts, or other modifications is not guaranteed. Inspect vehicle for modifications before installation of this product.

BEFORE INSTALLING OVERHEAD LIFTING DEVICE

An overhead-lifting device, such as chain falls, engine hoist, or cable come-a-long, can be used to lift the center section of the hitch in place. Lower a loop of rope or chain through the 4" hole in the truck bed floor and attach it to the latch pin in the round hitch receiver tube in the center section. Use the lifting device to raise the center section until the round hitch receiver tube that protrudes from the center section fits in the 4" hole in the truck bed floor. Maintaining upward pressure may facilitate fastening the crossmember to the center section, especially if the truck bed floor has been distorted downward from heavy use. If you use an overhead-lifting device, it should be disconnected before squaring the center section across the frame, installing the sideplates and torquing fasteners.

WARNING

Most trucks have FUEL LINES and/or BRAKE LINES and/or ELECTRICAL WIRES located along the frame rails where B&W Turnoverball™ hitches install. Carefully examine the location of fuel lines, brake lines and electrical wires BEFORE INSTALLATION. Be certain you will not damage fuel lines, brake lines or electrical wires when positioning hitch components, drilling holes, tightening fasteners, and lifting and lowering the truck bed. The fuel tank vent, located on top of the gas tank, can be easily damaged during the installation of the hitch components. Care must be taken when positioning the front crossmember and center section components.

WARNING

On the short bed trucks, **BEFORE INSTALLING THIS HITCH**, check for adequate turning clearance between the front of all of your trailers and the truck cab.

WARNING

DO not invert the ball in the socket when carrying heavy loads on 2 wheel drive trucks. The ball may hit the top of the differential. Remove the ball from the socket before loading. A plug for the socket is available from B & W.

INSTALLATION INSTRUCTIONS

STEP 1: MARKING AND CUTTING THE 4" HOLE IN THE TRUCK BED

Begin by marking the location for the hole in the truck bed floor. Measure from the back end (tail gate end) of the truck bed floor by hooking a tape measure over the back of the truck box and mark the floor at the correct location. Next, mark the center between the wheel wells. This will be the center point for the 4" hole. This location is critical to the correct installation of this hitch, so measure, mark, and saw carefully.

4" HOLE LOCATION

8' LONG BED - 48 3/8"

SHORT BED (BED LESS THAN 8') - 44 3/8"



NOTE:

If the truck has a plastic bed liner, you may drill through both, but it is more difficult to accurately locate the midpoint between the wheel wells, and to be sure that the bed liner does not move while sawing the hole. Make a 4 inch hole at this location using a four inch hole saw, or by marking a 4 inch circle and cutting it out with a saber saw equipped with a metal cutting blade.



STEP 2: CROSS-MEMBER INSTALLATION

From the under side of the truck, first position the rear cross member across the top of the frame rails, between the bed and frame then position the front cross member across the top of the frame rails, between the bed and frame. The cross members are installed by angling them over the rear end housing and exhaust pipe onto the passenger side frame rail until you clear the shock on the driver side of the truck. Position the front cross member against the truck bed cross member. Position the rear cross member with the slots facing the rear of the truck, with the horizontal side of the angle at the top, about 9" behind the front cross member.



STEP 3: CENTER SECTION INSTALLATION

Raise the center section into position between the cross-members from beneath the truck, with the latch pin release handle on the driver's side. A lifting device as described on page 1 will help. The round hitch receiver that protrudes from the top of the center section must fit through the hole in the truck bed floor. Next fasten the center section to the front cross-member using four of the 1 1/2" bolts. With a flat and lock washer on each bolt thread them into the threaded hole's in the front cross-member. Next install three 1 1/2" bolts from inside the center section through the matching hole in the rear cross-member (angle iron), install a flat washer, lock washer, and nut on the bolts. Do not fully tighten at this time.



Extended Cab Short Bed Only

Before installing the sideplates, it may be necessary to remove the metal tabs from the bed. The tabs are located on the cross-member in the front part of the wheel opening. These tabs serve no vital purpose except at the factory at the time of fabrication for alignment purposes.

Step 4: SIDEPLATE INSTALLATION

Square the assembled center section and cross-members across the frame. Then thread a 1 1/2" bolt with a flat and lock washer through the front flange of the side plate into the front cross-member (bar). Next place a bolt and flat washer through the rear side plate flange and the rear cross-member (angle iron) fasten with a flat washer, lock washer and nut. Align one front hole and one rear hole on the sideplates with the existing holes in the truck frame rails and fasten using 1 1/2" bolts. Install a flat washer on the head side of the bolt and flat and lock washer on the nut side. With the sideplates installed on both sides, torque all fasteners to 90 ft. lbs. In the following order. **First**, torque the center section to the front and rear crossmembers. **Second**, torque the side plates to the frame rails on both sides. **Third**, torque the side plate flange to the front and rear crossmembers on both sides.



STEP 5 – INSTALL LATCH PIN RELEASE HANDLE

WARNING: LATCH PIN WILL NOT FUNCTION PROPERLY IF HANDLE IS NOT INSTALLED CORRECTLY.

Install the latch pin release handle by inserting it through the slot in the end of the center section on the driver's side of the truck. Align the handle eyelet with the square hole in the latch pin so the handle is in line with the latch pin as shown. Secure the handle to the pin with the 5/16 X 3/4" carriage bolt and 5/16" locking flange nut as shown. Note: The included 5/16" cap screw can replace the carriage bolt if wrench access on the "cab side" of the handle is limited. Tighten the nut until it is secure. Do not over-tighten and deform the handle eyelet.

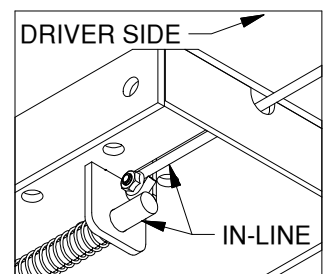
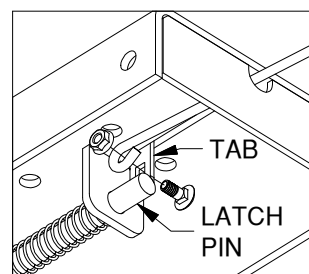

STEP 6: SAFETY CHAIN BRACKET INSTALLATION

Install the safety chain U-bolts. The center section may have multiple safety chain holes. Only 4 holes (2 on each side of the ball) will need to be drilled. Each U-bolt will need to rest in the low part of a bed rib. To determine which holes will need to be drilled, carefully examine the safety chain holes in the center section to determine which holes are under a low rib, See figure 6.1. Use a 1/2" Drill bit and drill through the bed in the 4 low rib locations, See Figure 6.2. Drop a U-bolt through each pair of holes from the top side of the truck bed floor. Place a conical spring and lock nut on each of the four legs. Tighten the lock nuts until flush with the bottom of the U-Bolts, See Figure 6.3.

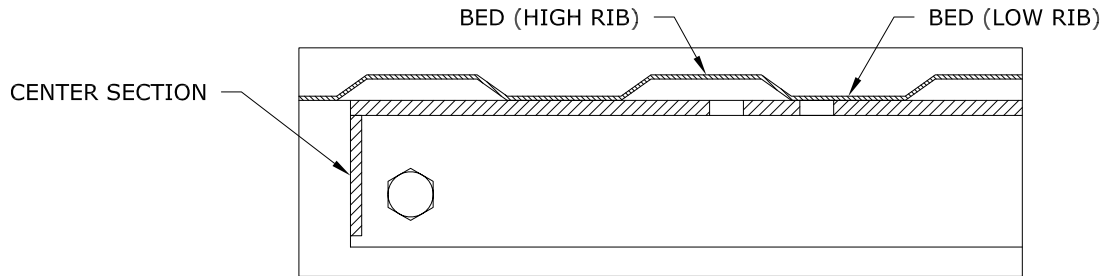

FIGURE 6.1: Cut away view of bed and center section

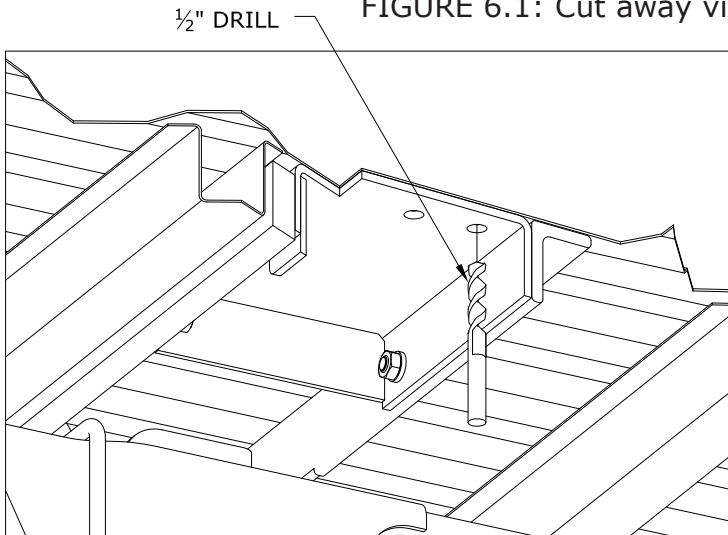

FIGURE 6.2: Cut away view from under the bed

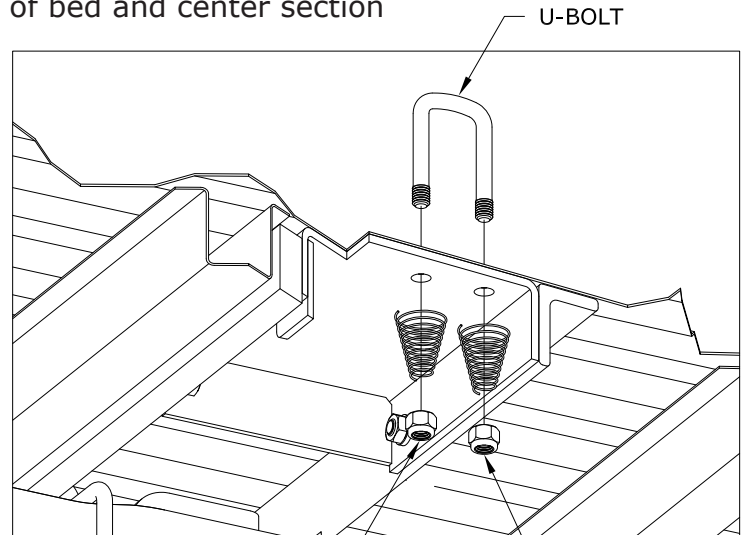

FIGURE 6.3: Cut away view from under the bed

STEP 7: HITCH BALL INSTALLATION

Retract the latch pin handle by pulling the handle all the way out until in stops and then rotating it clockwise. Place the 2-5/16" ball in the hitch receiver. Engage the latch pin handle by rotating the handle counter clockwise. Be certain the latch pin passes through the holes in the 2-5/16" ball and fully engages through the hitch receiver. Remove and grease the square base of the 2-5/16" ball.