



**B&W Trailer Hitches**  
 1216 Hawaii Road / PO Box 186  
 Humboldt, KS 66748  
 800.248.6564  
 620.473.3664  
 Fax:620.473.3766

**NOTE: We recommend reading instructions before beginning the installation.**

**WARNING: The tow vehicle's towing capacities should under NO circumstances be exceeded.**

# Turnoverball™ Gooseneck Hitch Installation Instructions

## Model 1059R

Call or Email us for Installation Support

hitches@turnoverball.com

[www.turnoverball.com](http://www.turnoverball.com)

**1999-2007 Chevrolet & GMC**  
**1/2 Light & heavy duty, 3/4 Ton Light Duty All Beds**  
**(Tube frame changing to C-Channel before axle)**  
**Includes 1/2 Ton Quad-Steer Models.**

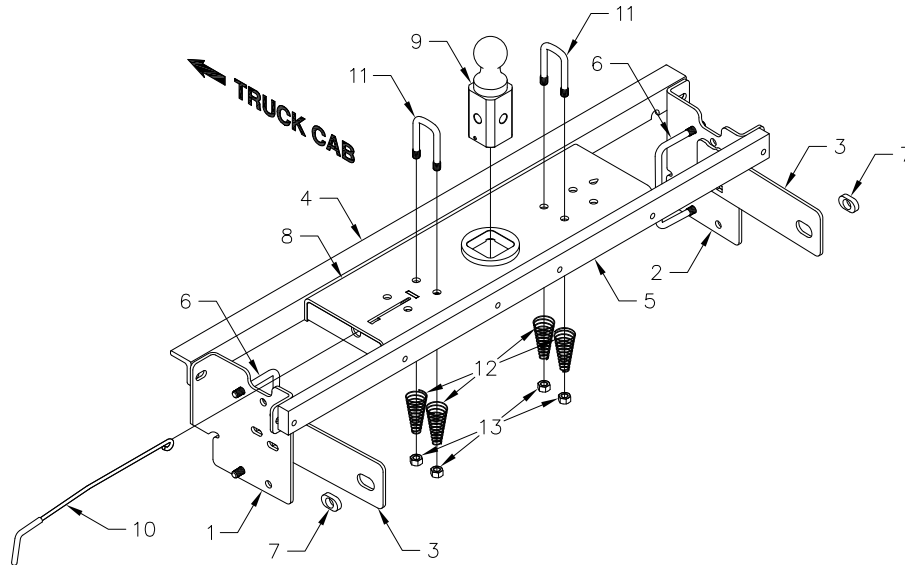

Mounting Kit Box (GNRM1059)		
ITEM	DESCRIPTION	QTY
1	Front Driver Side Plate	1
2	Front Passenger Side Plate	1
3	Rear Sideplates	2
4	Front Crossmember	1
5	Rear Crossmember	1
6	1/2" X 6-1/4" X 4" U-Bolt	2

Center Box (GNRC959N)		
ITEM	DESCRIPTION	QTY
8	Center Section	1
9	2-5/16" Ball	1
10	Latch pin Handle	1

Mounting Kit Bolt Bag		
7	Rear Sideplate Bushing	2
	1/2" X 1-1/4" Carriage Bolt	6
	1/2" X 1-1/2" Cap Screw	11
	1/2" Flat Washer	17
	1/2" Lock Washer	21
	1/2" Finish Nut	15
	3/4" Cap Screw	2
	3/4" Flat Washer	4
	3/4" Lock Washer	2
	3/4" Finish Nut	2
	O-Ring	1

Safety Chain Kit Bolt Bag		
11	1/2" U-Bolt	2
12	Conical Springs	4
13	1/2" Lock Nut	4
	5/16" X 3/4" Carriage Bolt	1
	5/16" X 3/4" Cap Screw	1
	5/16" Lock Nut	1

**NOTICE:** This product was designed to fit vehicles in their original, "as manufactured" condition. Compatibility with vehicles having replacement parts, or other modifications is not guaranteed. Inspect vehicle for modifications before installation of this product.

# BEFORE INSTALLING

## OVERHEAD LIFTING DEVICE

An overhead-lifting device, such as chain falls, engine hoist, or cable come-a-long, can be used to lift the center section of the hitch in place. Lower a loop of rope or chain through the 4" hole in the truck bed floor and attach it to the latch pin in the round hitch receiver tube in the center section. Use the lifting device to raise the center section until the round hitch receiver tube that protrudes from the center section fits in the 4" hole in the truck bed floor. Maintaining upward pressure may facilitate fastening the crossmember to the center section, especially if the truck bed floor has been distorted downward from heavy use. If you use an overhead-lifting device, it should be disconnected before squaring the center section across the frame, installing the sideplates and torquing fasteners.

## WARNING

Most trucks have FUEL LINES and/or BRAKE LINES and/or ELECTRICAL WIRES located along the frame rails where B&W Turnover-ball™ hitches install. Carefully examine the location of fuel lines, brake lines and electrical wires BEFORE INSTALLATION. Be certain you will not damage fuel lines, brake lines or electrical wires when positioning hitch components, drilling holes and tightening fasteners. The fuel tank vent, located on top of the gas tank, can be easily damaged during the installation of the hitch components. Care must be taken when positioning the front crossmember and center section components.

## WARNING

On Short bed trucks, BEFORE INSTALLING THIS HITCH, check for adequate turning clearance between the front of all of your trailers and the truck cab.

## WARNING

**DO NOT invert** the ball in the socket when carrying heavy loads on 2 wheel drive trucks. The ball may hit the top of the differential. Remove the ball from the socket before loading. A plug for the socket is available from B & W.

# INSTALLATION INSTRUCTIONS

## STEP ONE - REMOVE SPARE TIRE AND HEAT SHIELD

The heat shield under the bed floor must either be removed or a section cut out for the hitch assembly to be installed.

- A) Remove the heat shield from in front of the back crossmember.
- B) Remove the heat shield from the back of the crossmember located near the front of the wheel well.



## STEP TWO - REMOVE EXHAUST BRACKET

To ease installation of the center section it is necessary to remove the lower exhaust bracket. Simply pull the hanger rod out of the rubber bracket hole, a 6" to 8" wood block can then be positioned between the exhaust pipe and frame of the truck. This will increase your clearance between the top of the exhaust pipe and the bottom of the truck bed floor. (**Caution:** Exhaust pipe may be hot).

## STEP THREE- MARKING AND CUTTING 4 INCH HOLE IN TRUCK BED

Begin by verifying and measuring the correct hole location in the truck bed floor. Measure from the back end (tailgate end) of the truck bed floor by hooking a tape measure over the back of the truck box and mark the floor at the correct measurement. Next, center the location between the wheel wells. This will be the center point for the four inch hole. This location is critical to the correct installation of this hitch, so measure, mark and saw carefully. If the truck has a plastic bed liner, you may drill through both, but it is more difficult to accurately locate the midpoint between the fender wheel wells, and to be sure that the bed liner does not move while sawing the hole. Make a 4 inch hole at this location using a four inch hole saw, or by marking a 4 inch circle and cutting it out with a saber saw equipped with a metal cutting blade.

**TIP: B&W uses a 3/4" piece of plywood as a drilling guide to prevent the hole saw from moving while drilling the 4" hole in the bed.**

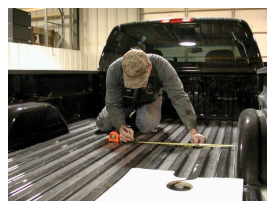
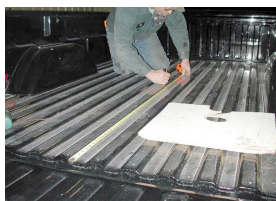

**4" HOLE LOCATION**  
**8' LONG BED - 49 1/2"**  
**SHORT BED (BED LESS THAN 8' LONG) - 44 1/4"**

## STEP FOUR-CROSS MEMBER INSTALLATION

Install the two cross members. They will be installed by sliding them from inside the wheel well, above the tire, through the gap between the bed and the truck's frame and across until they span the frame rails. The gap between the bed and frame is large enough to allow this, but the gap is partially obstructed by a sheet metal flange (about 1" in height) that is hanging down from the bottom of the truck bed floor. (See diagram and photos). A small notch needs to be made in this flange on the passenger side of the truck. Locate the center truck bed cross member. Measure over 2 1/2" from the front of the cross member and make a mark. This will be the center point of the notch that is needed. Mark a 1" wide by 1/2" tall notch. Remove the metal of the marked area with sheet metal shears. This will allow the front angle iron crossmember to be installed.

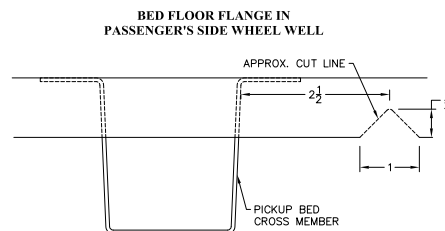

### STEP FIVE - CROSS MEMBER INSTALLATION

Place the 48" front cross member between the truck frame and bed floor using the notch made in step four. Be sure the holes in the cross member are facing to the rear of the truck. Slide the cross member across both frame rails. Using the rubber O-ring provided, secure a 1/2" x 1 1/2" long bolt into the second hole in the cross member from the driver's side. Slide the crossmember forward to the front edge of the 4" hole in the bed. Next install the 46 1/2" rear cross member bar between the truck frame and bed floor. Rotate the rear cross member a quarter turn so the threaded holes are offset to the bottom of the bar and slide back until there is enough room for the center section to be placed between the two cross members.

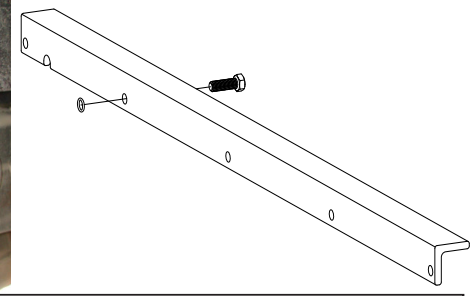

### APPLICATION UPDATE:

Beginning in 2004, a fuel valve mounted on the rear of the fuel tank on trucks equipped with gas engines, makes it more difficult to install the Turnoverball™ center section. This fuel valve can be easily removed and replaced to ease installation. Please follow the following instructions:



**Step 1:**  
Locate the fuel valve.



**Step 2:**  
Disengage the locking pin.



**Step 3:**  
Slide fuel valve from bracket.



**Step 4:**  
Install Turnoverball™ Center Section.

**Step 5: Replace fuel valve to bracket on fuel tank.**

### STEP SIX - CENTER SECTION INSTALLATION

Raise the center section into position between the crossmembers and carefully move it above the fuel tank from beneath the truck. The receiver socket must be positioned to the rear with the latch pin release arm on the driver's side. A lifting device, as described on Page 1 will help. The round hitch receiver that protrudes from the top of the center section must fit through the hole in the truck bed floor. Slide the front cross member back against the center section so that the bolt installed previously in the front cross member goes into the center section hole directly across from it. Line up the rest of the holes and attach the two members with 1/2" x 1 1/2" long bolts, lock washers, and nuts. Insert 1/2" x 1 1/2" bolts, with flat and lock washer installed, through the rear leg of the center section into the threaded holes of the rear cross-member and hand tighten.



### STEP SEVEN - INSTALL SIDEPLATES

Next install the sideplates. The driver's sideplate is shown, with the bent flange to the front, and the large hole to the rear. Attach the two pieces of the sideplate together with 1/2" carriage bolts. The carriage bolts should be inserted into the square holes from the backside of the sideplates and fastened using a flat washer, lock washer and nut on each bolt. This can be completed before installation on the frame rail. Do not tighten at this time. Attach the flange on the sideplate to the front cross member using a 1/2 x 1 1/2 inch bolt, flat washer, lock washer and nut. Insert the bolt through the flange so that the nut when tightened is on the front side of the cross member. Next attach the rear bar to the sideplate ear threading a 1/2 inch by 1 1/2 inch bolt with flat and lock washer installed into the bar.



**Installation Note: 1999-2003 Light Duty  
1/2 & 3/4 Ton Trucks  
2004 Light Duty 3/4 Ton Trucks**

Install the side plate on the **Light Duty Trucks** by utilizing the U-bolt placement holes at the rear of the side plate. Front placement holes are for **Standard 1/2 Ton** applications.

## STEP EIGHT

Install the 1/2-inch x 6 1/4-inch U-bolt from inside the frame through the holes in the sideplate above and below the frame, use a lock washer and nut on each end of the U-bolt. Repeat this procedure on the passenger side of the truck with the other sideplate. (While installing the U-bolts around the frame use caution not to damage or pinch the wiring harness or brake lines). Install the 3/4-inch by 2 1/2-inch bolt. Place a flat washer and frame insert on the 3/4" bolt and install the bolt from inside the frame through the rear hole in the side plate. The 3/4" bolt fastens with a lock washer and nut. (The holes in the frame and the sideplate are slotted and B&W provides an insert that converts the slotted holes to a 3/4" round hole. When installed correctly the frame insert will seat firmly in the slotted hole in the frame and the slotted hole in the sideplate). When completed, tighten all the hardware in this order: 1. Tighten the center section bolts to the cross members to 80 ft pounds. 2. Make certain the hitch is square with the frame. 3. Tighten the 3/4" side plate bolts to 120 ft pounds. 4. Tighten the frame clamping U-bolts slowly, alternating between the top and bottom legs of the U-bolt until equally tightened to 40 ft pounds. 5. Tighten the three carriage bolts on each side to 60 ft pounds. 6. Tighten the side plate to the front and rear cross members to 80 ft pounds.



## STEP NINE – INSTALL LATCH PIN RELEASE HANDLE

**WARNING: LATCH PIN WILL NOT FUNCTION PROPERLY IF HANDLE IS NOT INSTALLED CORRECTLY.**

Install the latch pin release handle by inserting it through the slot in the end of the center section on the driver's side of the truck. Align the handle eyelet with the square hole in the latch pin so the handle is in line with the latch pin as shown. Secure the handle to the pin with the 5/16 X 3/4" carriage bolt and 5/16" locking flange nut as shown. Note: The included 5/16" cap screw can replace the carriage bolt if wrench access on the "cab side" of the handle is limited. Tighten the nut until it is secure. Do not over-tighten and deform the handle eyelet.

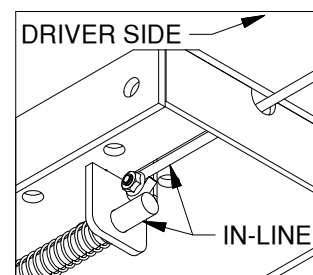
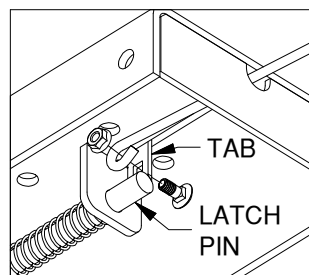

## STEP TEN - INSTALL SAFETY CHAIN BRACKETS

To install the safety chain brackets it is necessary to drill four 1/2" holes through the truck bed floor. Drill the holes from beneath the truck, through the two holes located on each side **and closest to the round receiver tube in the center section**. This will locate the safety chain brackets in the lowest point of the floor corrugation. Drop a U-bolt through each pair of holes from the topside of the truck bed floor. Place a spring and lock nut on each of the four legs. Tighten the lock nuts until flush with the bottom of the U-bolts.



## STEP ELEVEN - REPLACE THE EXHAUST BRACKET

Replace the exhaust hanger brackets and the spare tire if removed during step 2 of the installation.