



B&W Trailer Hitches
 1216 Hawaii Road / PO Box 186
 Humboldt, KS 66748
 800.248.6564
 620.473.3664
 Fax:620.473.3766

NOTE: *We recommend reading instructions before beginning the installation.*

WARNING: *The tow vehicle's towing capacities should under NO circumstances be exceeded.*

Turnoverball™ Gooseneck Hitch Installation Instructions

Model 1251R

Call or Email us for Installation Support

**Toyota Tundra
 (2000 - 2006)**

hitches@turnoverball.com
 www.turnoverball.com

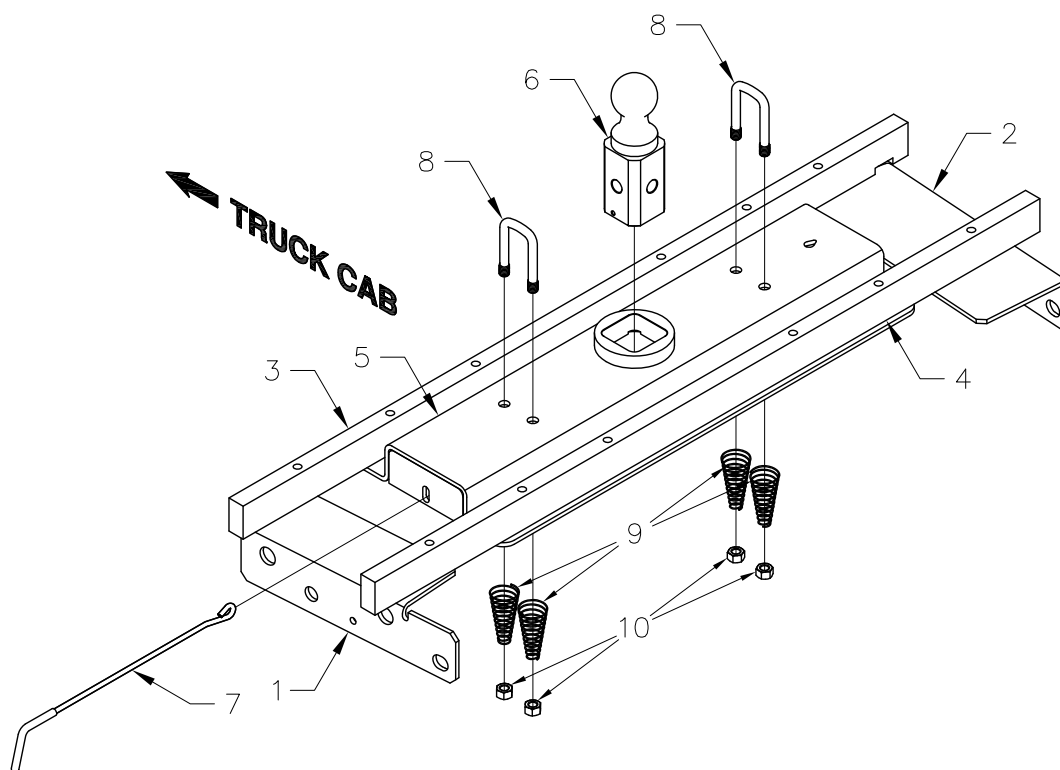

Mounting Kit Box (GNRM1251)		
ITEM	DESCRIPTION	QTY
1	Front Driver Side Plate	1
2	Front Passenger Side Plate	1
3	Front Crossmember	1
4	Rear Crossmember	1

Center Box (GNRC1250)		
ITEM	DESCRIPTION	QTY
5	Center Section	1
6	2-5/16" Ball	1
7	Latch pin Handle	1

Mounting Kit Bolt Bag		
	1/2" X 1-1/2" Cap Screw	12
	1/2" Flat Washer	12
	1/2" Lock Washer	12
	3/4" X 2-1/2" Cap Screw	4
	3/4" Flat Washer	8
	3/4" Lock Washer	4
	3/4" Finish Nut	4

Safety Chain Kit Bolt Bag		
8	1/2" U-Bolt	2
9	Conical Springs	4
10	1/2" Lock Nut	4
	5/16" X 3/4" Carriage Bolt	1
	5/16" X 3/4" Cap Screw	1
	5/16" Lock Nut	1

NOTICE: This product was designed to fit vehicles in their original, "as manufactured" condition. Compatibility with vehicles having replacement parts, or other modifications is not guaranteed. Inspect vehicle for modifications before installation of this product.

BEFORE INSTALLING

OVERHEAD LIFTING DEVICE

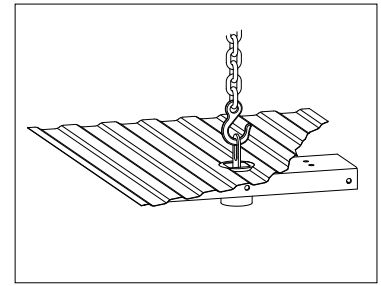

An overhead-lifting device, such as chain falls, engine hoist, or cable come-a-long, can be used to lift the center section of the hitch in place. Lower a loop of rope or chain through the 4" hole in the truck bed floor and attach it to the latch pin in the round hitch receiver tube in the center section. Use the lifting device to raise the center section until the round hitch receiver tube that protrudes from the center section fits in the 4" hole in the truck bed floor. Maintaining upward pressure may facilitate fastening the crossmember to the center section, especially if the truck bed floor has been distorted downward from heavy use. If you use an overhead-lifting device, it should be disconnected before squaring the center section across the frame, installing the side plates and torquing fasteners.

WARNING

Most trucks have FUEL LINES and/or BRAKE LINES and/or ELECTRICAL WIRES located along the frame rails where B&W Turnoverball™ hitches install. Carefully examine the location of fuel lines, brake lines and electrical wires BEFORE INSTALLATION. Be certain you will not damage fuel lines, brake lines or electrical wires when positioning hitch components, drilling holes, tightening fasteners, and lifting and lowering the truck bed. The fuel tank vent, located on top of the gas tank, can be easily damaged during the installation of the hitch components. Care must be taken when positioning the front crossmember and center section components.

Warning

On Short bed trucks, BEFORE INSTALLING THIS HITCH, check for adequate turning clearance between the front of all of your trailers and the truck cab.

Warning

DO NOT invert the ball in the socket when carrying heavy loads on 2 wheel drive trucks. The ball may hit the top of the differential. Remove the ball from the socket before loading. A plug for the socket is available from B & W.

INSTALLATION INSTRUCTIONS

General Information

The Toyota Tundra truck has two bed cross members about six inches apart over the rear axle. A special center section has been developed to fit between these two bed cross members. The center section is formed to allow the Turnoverball™ cross bars to be located in front of and behind the bed cross members. Because the center section fits so closely between the cross members, it is **very important that the 4" hole in the truck bed floor be carefully measured and precisely located.** This hitch also utilizes side plates that attach to the **inside** of the truck frame rails, rather than the outsides of the frame as do other Turnoverball™ hitches.

STEP ONE

Begin by verifying and measuring the correct hole location in the truck bed floor. Measure from the back end (tail gate end) of the truck bed floor by hooking a tape measure over the back of the sheet metal and marking the floor at the **46 1/4"**. Center the measurement between the fender wheel wells. This location is critical to the correct installation of this hitch, so measure, mark and saw carefully. If the truck has a plastic bed liner, you may drill through both, but it is more difficult to accurately locate the midpoint between the fender wheel wells, and to be sure that the bed liner does not move while sawing the hole. Make a four-inch hole at this location using a four-inch hole saw, or by marking a four-inch circle and cutting it out with a saber saw equipped with a metal cutting blade.



STEP TWO

Before positioning the cross bars, move the electrical wire harness by pulling the plastic clips loose from the driver's side frame rail. Select the front cross bar. The front cross bar has a notch machined at one end for clearance over a frame rivet. With the drilled and tapped holes down and the notch to the passenger side of the truck, maneuver the bar to where it is on top of the frame in front of the bed cross member forward of the 4" hole. Now put the back cross bar above the frame behind the bed cross member rearward of the 4" hole with the drilled and tapped holes down.

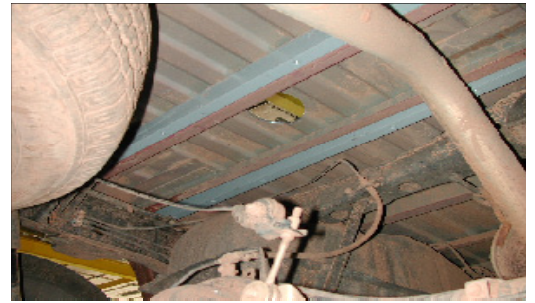

STEP THREE

With the latch pin mechanism on the driver's side, raise the center section of the hitch into position between the cross members from beneath the truck. The round receiver tube that protrudes from the center section must fit through the hole in the truck bed floor. If you are using an overhead-lifting device, attach the lifting device to the latch pin through the receiver tube to help support the center section. Align the holes in the bars with the center section bridging bars, and fasten the center section to the cross bars using the eight 1/2" X 1 1/2" bolts, with a lock washer on each. Use the overhead lifting device to put some upward pressure on the center section if necessary to aid alignment.

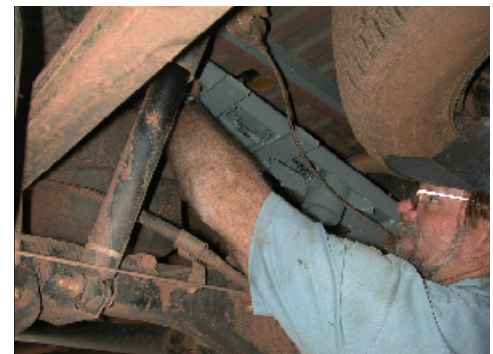

STEP FOUR

Now install the Side Plates. On the driver's side, inside the frame rail, take the brake lines loose by removing the plastic clip holder from the frame. Lifting the plastic stud from the outside of the frame with a hammer will easily get it loose. Pull the brake lines away from the frame only far enough to slip the side plate in behind them. These side plates are bent to an angle shape, and the wider of the two sides is to the top, and the two slots in the top are to align with, and bolt to, the holes in the cross bars. Determine which is for the right and left side of the truck. The driver's side-Side Plate has a large notch removed from the back end. Start bolts (1/2" x 1 1/2") using a flat washer and lock washer on each into the bar through the top slots. The vertical side of each side plate has large holes that align with holes in the truck frame rail. Install the bolts (3/4 x 2") with a flat washer on each side, and a lock washer and nut, from the outside of the frame to the inside. Tighten all fasteners.



STEP FIVE

To install the safety chain brackets it is necessary to drill four 1/2" holes through the truck bed floor. Drill the holes from beneath the truck, through the four holes located near the round hitch receiver tube in the center section. From the topside of the truck floor, insert a U-bolt through each pair of holes. Place a spring and lock nut on each of the four legs. Tighten the lock nuts until 1/4" of thread extends through the lock nut.



STEP SIX

WARNING: LATCH PIN WILL NOT FUNCTION PROPERLY IF HANDLE IS NOT INSTALLED CORRECTLY.

Install the handle from underneath the truck by inserting it through the slot in the end of the center section toward the driver's side rear tire as shown. Attach the handle to the latch pin as shown with the handle on the "cab side" of the square tab welded to the pin. The head of the bolt must be on the handle side, and the lock nut must be on the tab side. The tab is welded to the pin in an offset position so that the handle will be lined up over the center of the pin. If the handle is fastened to the other side of the tab, the handle will not function properly.

When installed correctly the latch pin may be disengaged from the ball by pulling on the handle from the driver's side wheel well and rotating the handle clockwise.

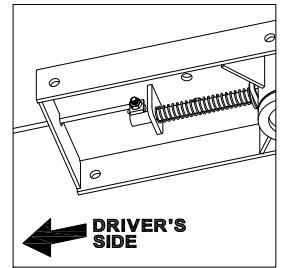
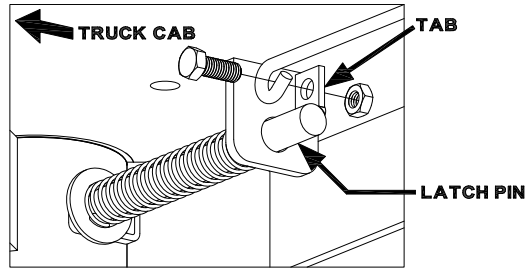
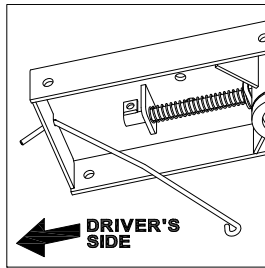

STEP SEVEN

Retract the latch pin by pulling the handle out until it stops, and then sliding it toward the front of the truck. Place the 2-5/16" ball in the hitch receiver. Engage the latch pin by pulling the handle and then sliding it rearward and back to the locking position. Be certain the latch pin passes through the holes in the 2-5/16" ball and engages completely through the hitch receiver socket. Grease the square base of the 2-5/16" ball on all sides.