



BX2723

2011-16 Kia Sportage Installation Instructions

Attachment Tab Height: 16-1/2"

Attachment Tab Width: 23"

Serial Number

Please read BOTH these Installation Instructions and the General Instructions prior to installing or operating this equipment.

- Blue Ox® towing products and accessories are intended to be installed by Blue Ox® Dealers who are familiar with our products and have the equipment and knowledge necessary to do "fit work". If needed, Blue Ox® Dealers can be found at www.blueox.com or by contacting our Technical Service Department at (402) 385-3051.
- Many Blue Ox® baseplates are designed to use existing holes and hardware to mount the baseplate to the towed vehicle. Even though bolts are there, do not assume they are adequate for baseplate mounting. Always use the hardware supplied in the hardware kit and existing hardware as specified in the installation instructions.



If the front of your vehicle looks different than this, please contact us at (402)385-3051.

Reference your vehicle owner's manual for manufacturer's towing specifications.

Bolt Torque Specifications

Torque in Foot-Pounds for Inch Bolts

Bolt Size	Grade 5	Grade 8
1/4"	10	14
5/16"	19	29
3/8"	33	47
7/16"	54	78
1/2"	78	119
5/8"	154	230
3/4"	257	380

Bolt Torque Specifications

Torque in Foot-Pounds for Metric Bolts

Bolt Size	Grade 8.8	Grade 10.9
6MM	6	8
8MM	16	22
10MM	31	40
12MM	54	70
14MM	89	117
16MM	161	230
18MM	222	318



WARNING

Failure to read and follow these instructions could result in separation of the towed vehicle from the tow bar, causing property damage, loss of towed vehicle, personal injury or death.

BX2723
2011-16 Kia Sportage
Installation Instructions

Instruction Notes: The fascia, bumper, and temperature sensor are removed and reinstalled for the baseplate installation. Some drilling and trimming is required.

The dimensional variations between otherwise identical vehicles can be considerable. While the baseplate was designed for easy installation, it may be necessary to tailor the baseplate slightly to compensate for vehicle manufacturer's tolerances. These minor adjustments may include filing a hole slightly, bending electrical rods or bending end plates.

The BX8869 Tail Light Wiring Kit is recommended for this vehicle.

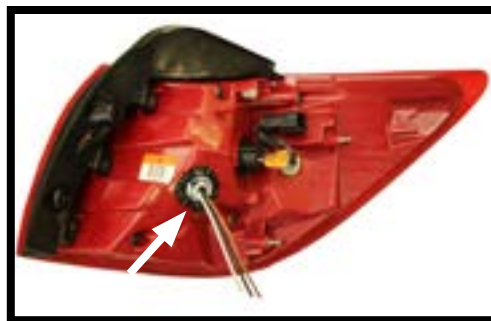

Drill a hole according to the tail
light wiring kit instructions.

NOTICE

- Handling of some cosmetic parts when installing this product may require the use of protective covers, rags, specialty tools, etc. to prevent damage.
- When using power drills be aware of the dangers of torque and drill bit length.
- When using a reciprocating saw be aware of objects behind the cutting surface.
- Use a good quality paint to spray cut edges of frame to prevent rusting.
- Be sure that **ALL** electrical connections are plugged in and accessories are functioning properly before reinstalling the fascia.
- The baseplate is computer tested to your vehicle's GVWR, exceeding this weight will void the manufacturer's warranty.
- Be sure to use a sufficient amount of Loctite® Red on all bolt threads before tightening. Tighten all bolts according to the torque chart provided.
- Dealer or installer be certain the user receives these instruction sheets.
- If the baseplate is in an accident, it must be replaced. **DO NOT** use it again! An accident can cause unseen damage and using it again could result in more damage or serious injury. **DO NOT** use the baseplate if it is damaged or missing parts.

BX2723 2011-16 Kia Sportage Installation Instructions

Tools Required

8MM Socket
10MM Socket
12MM Socket
9/16" Socket
9/16" Wrench
Large Vise Grip
Phillips Screwdriver
Flat Screwdriver
Torque Wrench
Tape Measure
Drill
13/32" Drill Bit
Loctite® Red

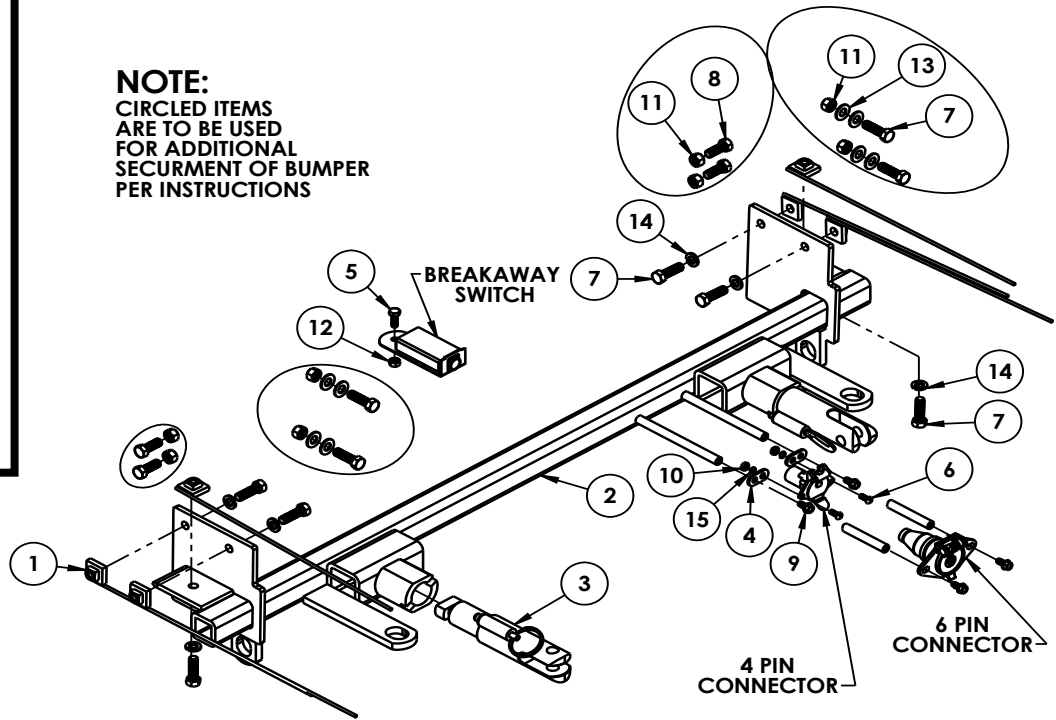

NOTE:
CIRCLED ITEMS
ARE TO BE USED
FOR ADDITIONAL
SECUREMENT OF BUMPER
PER INSTRUCTIONS

Item No.	Part No.	Description	Qty.
1.....	61-5208	Nut Plate Weldment with Wire	6
2.....	61-6999	BX2723 Baseplate	1
3.....	62-3468	Attachment Tab Assembly	2
4.....	101-5822	4 Way Connector Adapter	2
5.....	201-0050	1/4"-20 X 3/4" Hex Head Bolt Grade 5, ZP	1
6.....	201-0192	#10-32 x 1/2" Round Slotted Head Screw	2
7.....	201-0368	3/8"-16 x 1-1/4" Hex Head Bolt, Grade 5, ZP.....	10
8.....	201-0443	3/8"-16 x 1" Hex Head Bolt, Grade 5, ZP.....	4
9.....	201-0979	#12-14 x 1" Self Drilling Screw, ZP	2
10.....	202-0047	#10-32 Hex Nut.....	2
11.....	202-0090	3/8"-16 Hex Nut with Nylon Insert, ZP	8
12.....	202-0102	1/4"-20 Hex Nut with Nylon Insert, ZP	1
13.....	203-0003	3/8" Flat Washer, ZP	8
14.....	203-0010	3/8" Lock Washer, ZP.....	6
15.....	203-0054	#10 Lock Washer, ZP.....	2
16 (not shown).....	226-0046	36" Class III Baseplate Safety Cable	2
17 (not shown).....	229-0359	3/8" Quicklink , ZP.....	2
18 (not shown).....	290-0437	Black Cap Plug Receiver	2

Important:

Use only genuine factory replacement parts on your baseplate. Do **NOT** substitute homemade or non-typical parts. If a bolt is lost or in need of replacement, for your safety and the preservation of your baseplate, be sure to use a replacement bolt of the same grade (In most cases it will be Grade 5, please reference the parts list above). Replacement parts may be ordered through your nearest Blue Ox® Dealer or Distributor. Failing to follow and/or altering these installation instructions in either installation or required equipment will void the manufacturer's warranty. Towing behind a non-motorized vehicle will void the warranty.

BX2723
2011-16 Kia Sportage
Installation Instructions

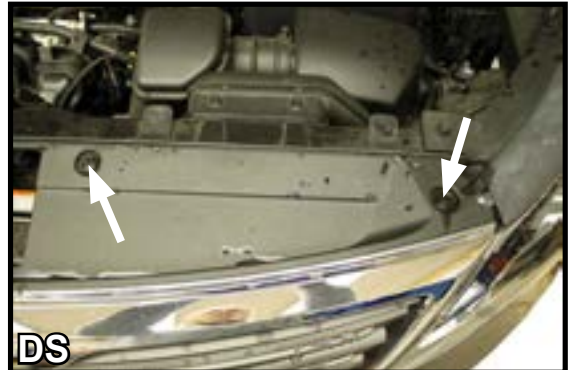
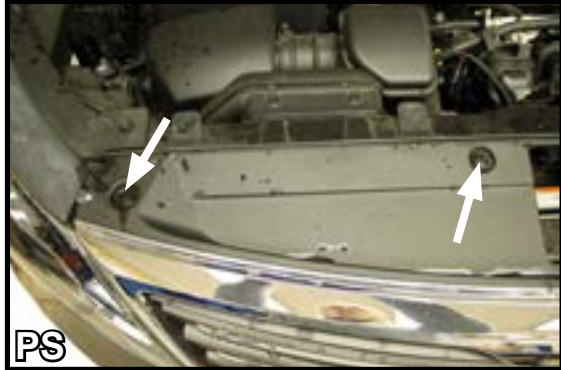

1. With a 10MM socket, remove the bolt from the top portion of the fascia on each side. Remove push pin, one (1) per side.



2. In the wheel well area directly ahead of the front tire towards the bottom is an 8MM bolt that needs to be removed. Further up along the trim there is a push pin that will also need to be removed in order to remove the front fascia.

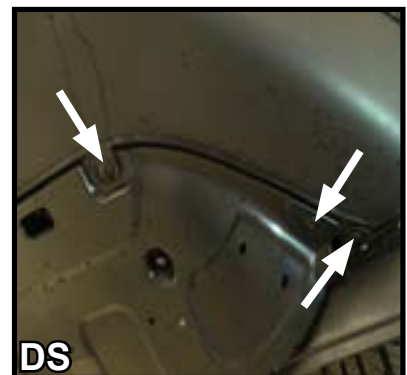
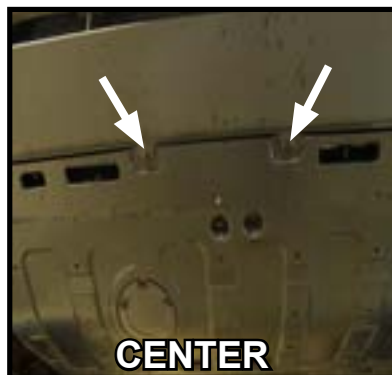
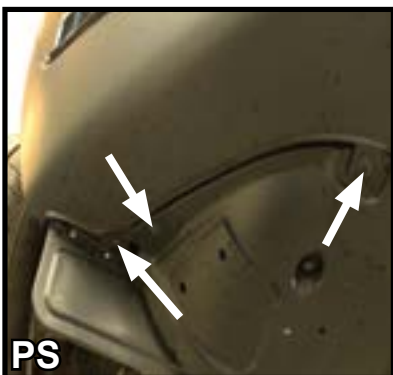

3. Remove the three (3) push pins that are located underneath the vehicle towards the outer edge. There are two (2) push pins located in the center of the vehicle that also need to be removed.

BX2723
2011-16 Kia Sportage
Installation Instructions

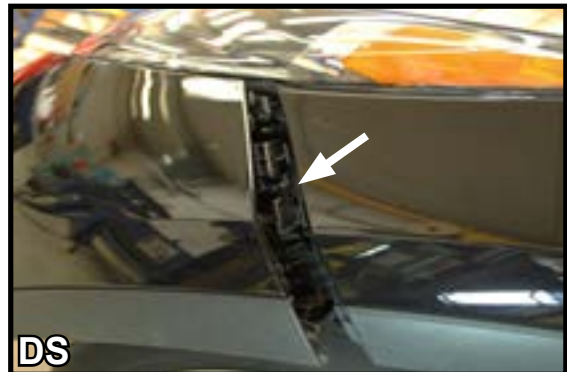
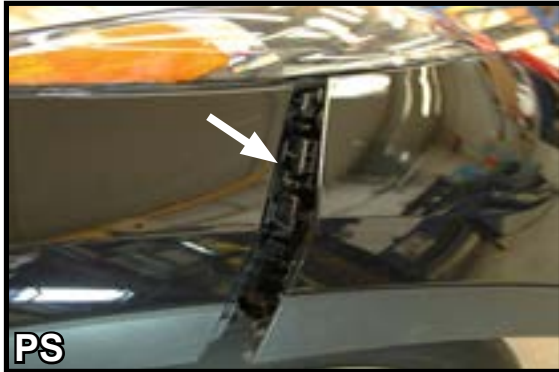

4. Firmly lift up on the sides. If necessary, a flat screwdriver may be used. We recommend you place a cloth over the screwdriver to prevent scratching your vehicle surface.

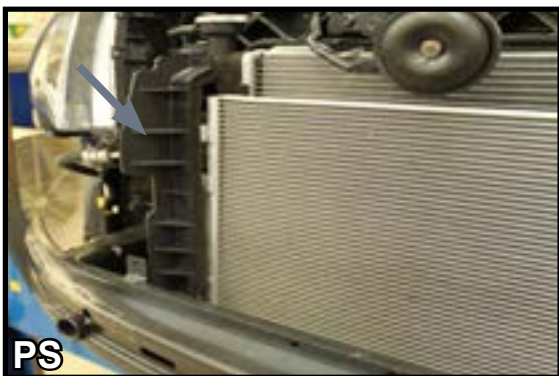

5. Remove the plastic brackets along side the radiator by sliding upward.

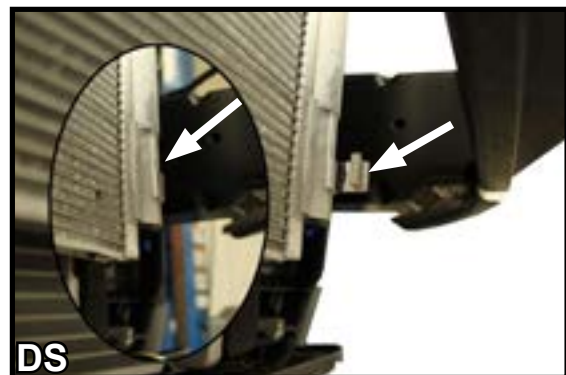
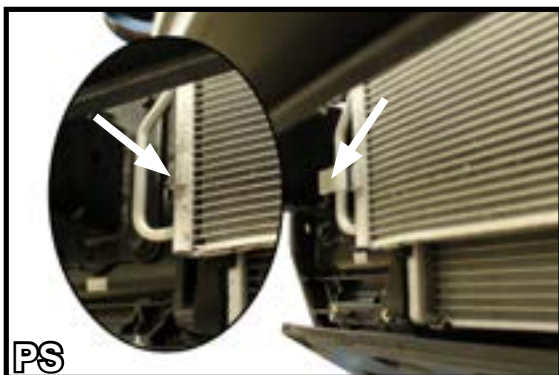

6. After removing the plastic brackets trim the aluminum clips.

BX2723
2011-16 Kia Sportage
Installation Instructions

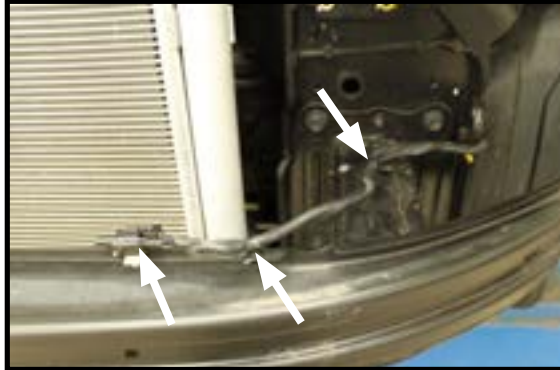

7. The temperature sensor will need to be temporarily relocated. Unclip it from the bumper and move off to the side.

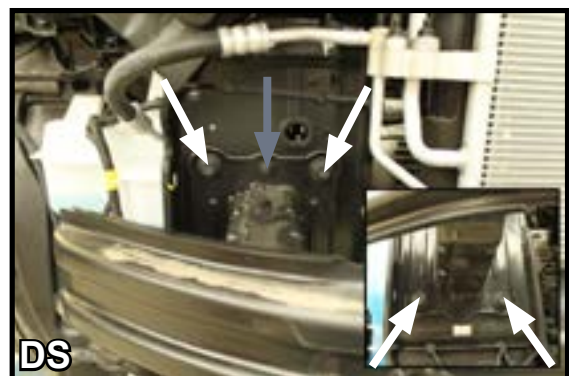
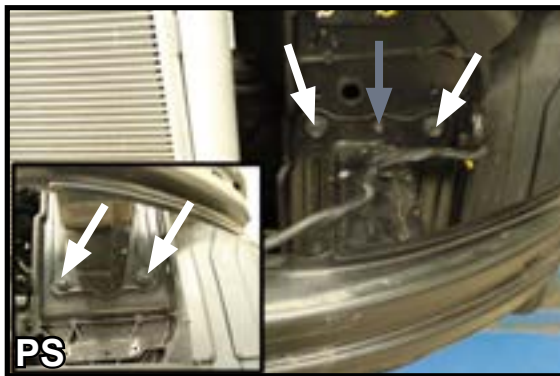

8. To remove the front bumper, use a 12MM socket to remove the four (4) outside bolts on the bumper mount bracket. There are two (2) on the top and two (2) on the bottom. The one (1) center bolt on top requires a 10MM socket.



9. Drill two (2) 3/8" holes thru the side plate using the spot welds as a guide. Insert two (2) 3/8"-16 x 1" hex head bolts and 3/8"-16 hex nuts. Do this on both sides on the vehicle.

BX2723
2011-16 Kia Sportage
Installation Instructions

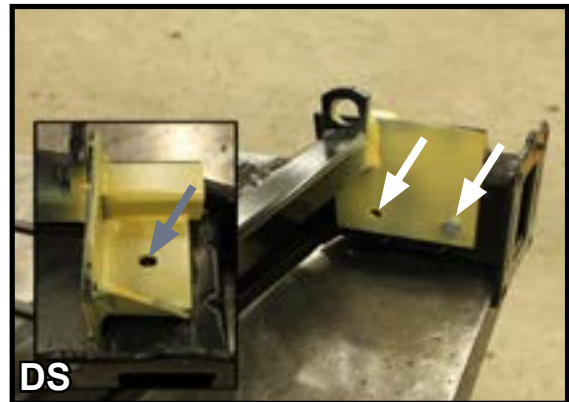
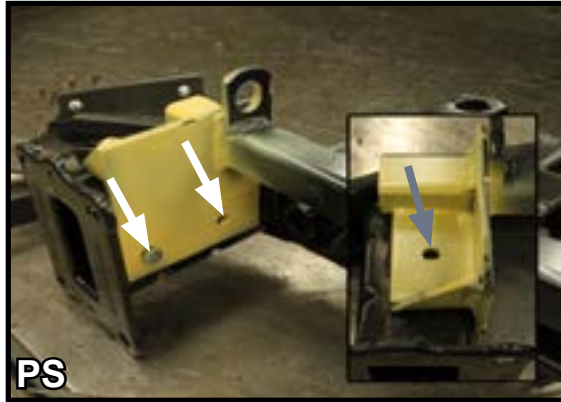

10. With the bumper lying upside down, place the baseplate on top and align the outer most holes. Using a 13/32" drill bit, drill the inner hole and the top hole.

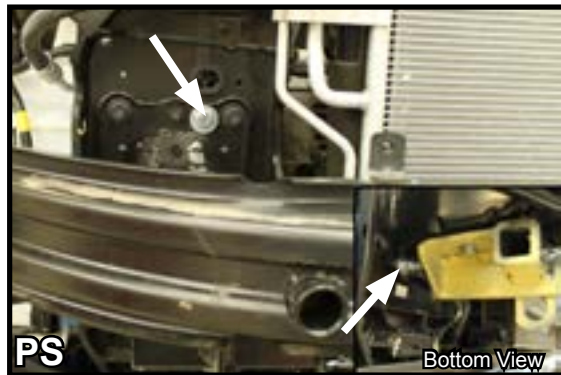

11. For additional support when reinstalling the front bumper you will need to drill two (2) 3/8" holes into the bumper mounting plate. Once the bumper is reinstalled securely, reattach the temperature sensor.

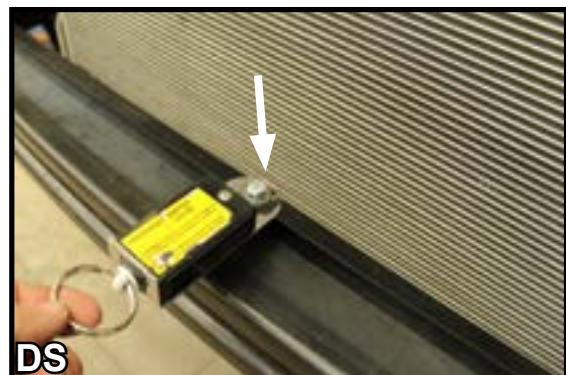
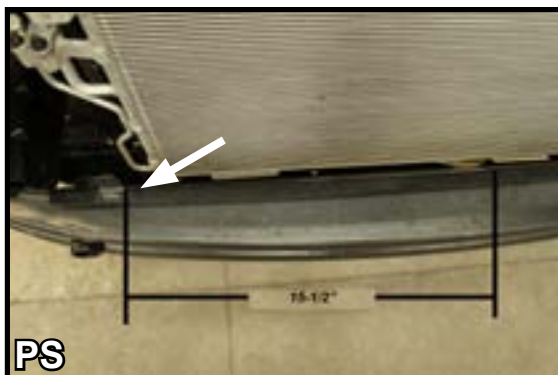

12. To install the breakaway switch measure 15-1/2" from the inside edge of the bracket. Drill a 1/4" hole.

BX2723
2011-16 Kia Sportage
Installation Instructions

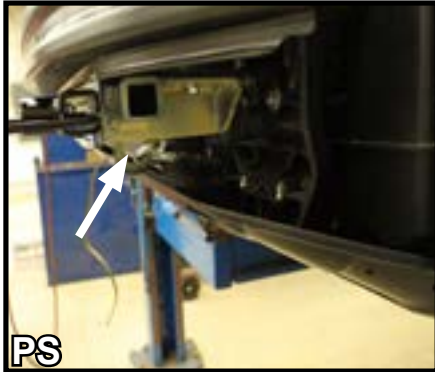

13. Attach the permanent baseplate safety cables to the provided convenience link on the baseplate. The photo above shows the recommended installation of the cables. Additional options may interfere with suggested mounting; in this case, secure the cables to a solid piece of the frame as described in the instructions included with the permanent baseplate safety cables. Be sure the safety cables do not rub against any hoses or moving parts. Do this on both sides of the vehicle.

14. Reinstall front fascia.

CUSTOMER SERVICE COMMITMENT

Blue Ox® is committed to providing you with exceptional customer care throughout your lifetime with our products. Our team is here to assist you with any questions you may have regarding the performance of your product. Simply call (402) 385-3051 and you can speak with our technical service team.

Additionally, please visit our website to see which rallies our Destination America team will be attending. For a nominal fee, our service technician will service your towing system to ensure it's in proper working condition. Also, as a commitment to our customers, should you visit our factory, you can stay at our full service Blue Ox® campground at no charge along with enjoying a factory tour.

Again, thank you for being our customer and for the confidence you have shown in the performance of our products. It is because of customers like you we enjoy the success we have today.

© 2015 Blue Ox
One Mill Road, Industrial Park
Pender, Nebraska 68047
Phone: (402) 385-3051
Fax: (402) 385-3360
www.blueox.com

General Information

1. Ensure that your product(s) are registered online at www.blueox.com. It is crucial to register your product(s) so that you may be alerted of product offerings, updates, upgrades, maintenance and safety bulletins, and/or recalls.
2. **It is the owner's responsibility to inspect all towing equipment for cracked welds, missing or worn parts and loose bolts before each towing trip.** Be sure to use Loctite® Red on all bolts and tighten to the recommended specifications.
3. **It is the owner's responsibility to hook up all towing equipment per manufacturer's instructions/recommendations.**
4. Remove the attachment tabs when not in use (if applicable).

Notice To Baseplate Installer

1. It is YOUR responsibility to watch for:

- Oil cooler and air conditioner lines
- Electrical wires and hoses
- Missing parts or attaching points on the frame

** If the baseplate is improperly installed and is against a wire or hose, it could cause fluid leaks or electrical shorts some time after the actual baseplate installation.

Permanent Baseplate Safety Cable Installation

Permanent baseplate safety cables are strongly recommended when towing a vehicle with a tow bar. The principle function of the permanent baseplate safety cables is to prevent the towed vehicle from breaking loose in the event the connection between the frame of the towed vehicle and the baseplate fails or becomes disconnected. The cables must be connected from the baseplate to the frame rail or cross member of the vehicle's frame. The illustrations below show the possible arrangements recommended by Blue Ox®. Each permanent baseplate safety cable must have an adequate weight rating for the towing system. The weight rating of the two (2) cables together will not qualify.

Do not mount the permanent baseplate safety cables against wires, hoses or brake lines.

These permanent baseplate safety cables should remain installed as long as the baseplate is installed on the vehicle. Permanent baseplate safety cables are to be used in conjunction with, and NOT a replacement for legally required safety cables attaching the towed vehicle to the towing vehicle.

OPTION #1

Permanent Baseplate Safety Cables to Cross Member or Frame of Towed Vehicle.

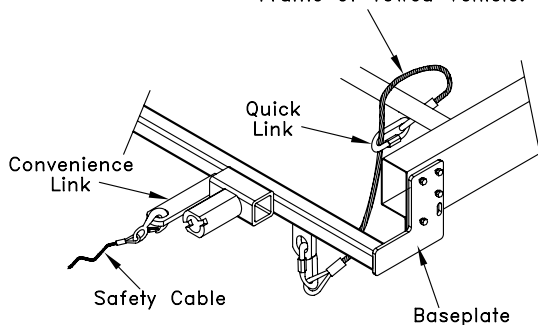

OPTION #2

Permanent Baseplate Safety Cables to Cross Member or Frame of Towed Vehicle.

