



## **BX2671**

2009-14 Ford F150 (No Raptor/King Ranch)  
2015-17 Ford Expedition  
2015-18 Ford F150  
2016-18 Ford F150 Raptor  
2015-17 Lincoln Navigator  
(Includes EcoBoost & ACC)  
Installation Instructions

Please read **BOTH** these Installation Instructions and the General Information sheet prior to installing or operating this equipment.

Serial Number

Attachment Tab Height: 17.5"

Attachment Tab Width: 35"



If the front of your vehicle looks different than this, please contact us at (402)385-3051.

Reference your vehicle owner's manual for manufacturer's towing specifications.

## BX2671

2009-14 Ford F150 (No Raptor/King Ranch) (Includes EcoBoost)  
2015-17 Ford Expedition, Lincoln Navigator (Includes EcoBoost & ACC)  
2015-18 Ford F150 (Includes EcoBoost & ACC)  
2016-18 Ford F150 Raptor (Includes ACC)  
Installation Instructions



If the front of your vehicle looks different than this, please contact us at (402)385-3051.

1. Blue Ox® towing products and accessories are intended to be installed by Blue Ox® Dealers who are familiar with our products and have the equipment and knowledge necessary to do “fit work”. If needed, Blue Ox® Dealers can be found at [www.blueox.com](http://www.blueox.com) or by contacting our Technical Service Department at (402) 385-3051.
2. Many Blue Ox® baseplates are designed to use existing holes and hardware to mount the baseplate to the towed vehicle. Even though bolts are there, do not assume they are adequate for baseplate mounting. Always use the hardware supplied in the hardware kit and existing hardware as specified in the installation instructions.

## WARNING

Failure to read and follow these instructions could result in separation of the towed vehicle from the tow bar, causing property damage, loss of towed vehicle, personal injury or death.

<b>Bolt Torque Specifications</b>		
Torque in Foot-Pounds for Inch Bolts		
Bolt Size	Grade 5	Grade 8
1/4"	10	14
5/16"	19	29
3/8"	33	47
7/16"	54	78
1/2"	78	119
5/8"	154	230
3/4"	257	380

<b>Bolt Torque Specifications</b>		
Torque in Foot-Pounds for Metric Bolts		
Bolt Size	Grade 8.8	Grade 10.9
6MM	6	8
8MM	16	22
10MM	31	40
12MM	54	70
14MM	89	117
16MM	161	230
18MM	222	318

## BX2671

2009-14 Ford F150 (No Raptor/King Ranch) (Includes EcoBoost)  
2015-17 Ford Expedition, Lincoln Navigator (Includes EcoBoost & ACC)  
2015-18 Ford F150 (Includes EcoBoost & ACC)  
2016-18 Ford F150 Raptor (Includes ACC)  
Installation Instructions

**Instruction Notes:** The bumper is removed and reinstalled for the baseplate installation. Some drilling and trimming is required. Tow hooks are removed and not reinstalled.

Place all components that are removed on a flat, sturdy surface. All items will be reinstalled unless otherwise noted after the baseplate is installed.

The dimensional variations between otherwise identical vehicles can be considerable. While the baseplate was designed for easy installation, it may be necessary to tailor the baseplate slightly to compensate for vehicle manufacturer's tolerances.

The BX8869 Tail Light Wiring Kit is recommended for non-LED equipped vehicle applications.

The BX8848 Diode Wiring Kit is recommended for LED equipped vehicle applications.

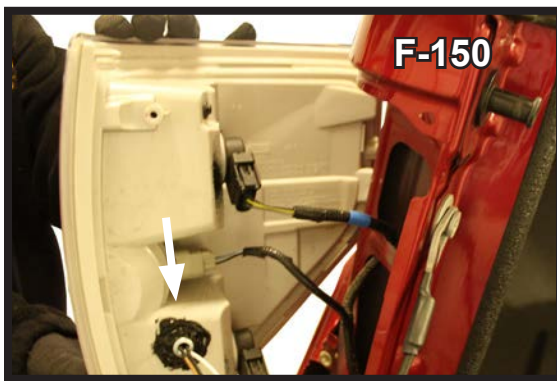

Drill a hole according to the tail light wiring kit instructions.

### **NOTICE**

- Handling of some cosmetic parts when installing this product may require the use of protective covers, rags, specialty tools, etc. to prevent damage.
- When using power drills be aware of the dangers of torque and drill bit length.
- When using a reciprocating saw be aware of objects behind the cutting surface.
- Use a good quality paint to spray cut edges of frame to prevent rusting.
- Be sure that **ALL** electrical connections are plugged in and accessories are functioning properly before reinstalling the fascia.
- The baseplate is computer tested to your vehicle's GVWR, exceeding this weight will void the manufacturer's warranty.
- Be sure to use a sufficient amount of Loctite® Red on all bolt threads before tightening. Tighten all bolts according to the torque chart provided.
- Dealer or installer be certain the user receives these instruction sheets.
- If the baseplate is in an accident, it must be replaced. **DO NOT** use it again! An accident can cause unseen damage and using it again could result in more damage or serious injury. **DO NOT** use the baseplate if it is damaged or missing parts.

# BX2671

2009-14 Ford F150 (No Raptor/King Ranch) (Includes EcoBoost)  
 2015-17 Ford Expedition, Lincoln Navigator (Includes EcoBoost & ACC)  
 2015-18 Ford F150 (Includes EcoBoost & ACC)  
 2016-18 Ford F150 Raptor (Includes ACC)  
**Installation Instructions**

## Tools Required

Torque Wrench  
 Drill  
 Tape Measure  
 Loctite® RED  
 17/32" Drill Bit  
 8MM Socket  
 10MM Socket  
 15MM Socket  
 21MM Socket  
 7/16" Socket  
 7/16" Wrench  
 3/4" Socket  
 3/4" Wrench  
 T30 Torx

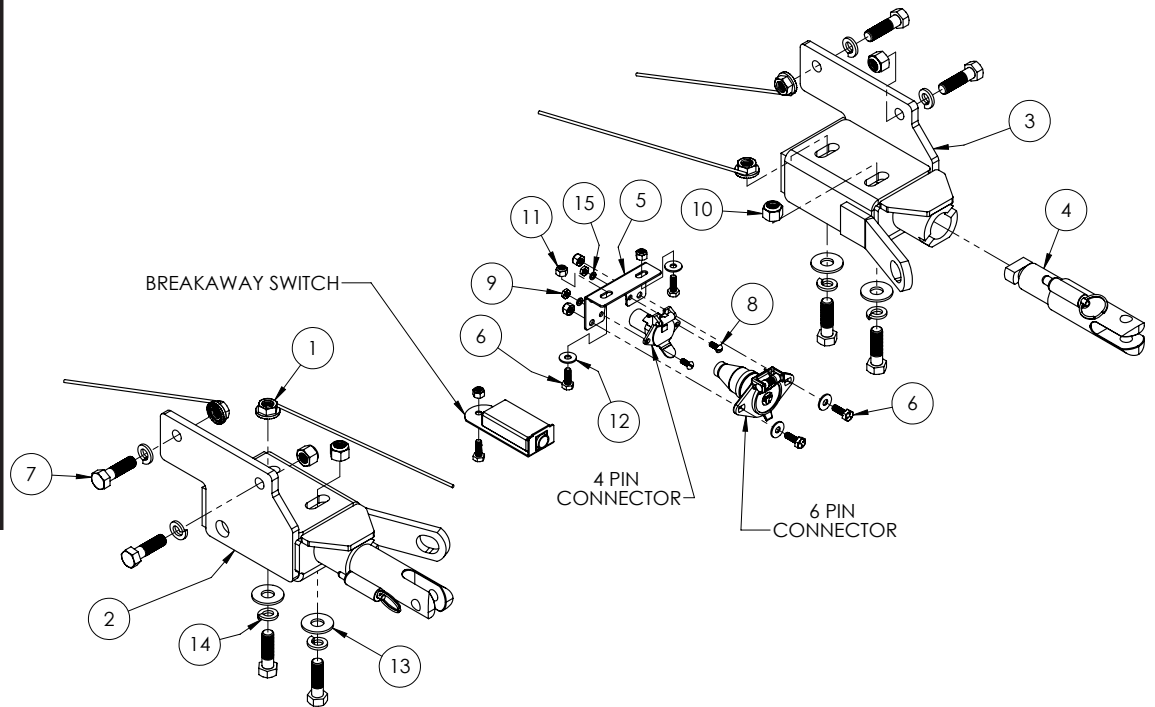

Item No.	Part No.	Description	Qty.
1.....	61-4029.....	1/2"-13 Nut Plate with 10" Wire.....	4
2.....	61-7895.....	BX2671 Passenger Side Baseplate.....	1
3.....	61-7894.....	BX2671 Driver Side Baseplate.....	1
4.....	62-3468.....	Attachment Tab with Hole.....	2
5.....	101-6135.....	90° Electrical Bracket.....	1
6.....	201-0050.....	1/4"-20 x 3/4" Hex Head Bolt, Grade 5, ZP.....	5
7.....	201-0068.....	1/2"-13 x 1-3/4" Hex Head Bolt, Grade 5, ZP.....	8
8.....	201-0192.....	#10-32 1/2" Round Slotted Head Screw.....	2
9.....	202-0047.....	#10-32 Hex Nut.....	2
10.....	202-0094.....	1/2"-13 Hex Lock Nut with Nylon Insert.....	4
11.....	202-0102.....	1/4"-20 Hex Nut with Nylon Insert.....	5
12.....	203-0001.....	1/4" Flat Washer, ZP.....	4
13.....	203-0005.....	1/2" Flat Washer, ZP.....	4
14.....	203-0012.....	1/2" Lock Washer, ZP.....	8
15.....	203-0054.....	#10 Lock Washer.....	2
16.....	226-0049 (not shown).....	36" Class IV Safety Cables.....	2
17.....	229-0512 (not shown).....	1/2" Quicklink, ZP.....	4
18.....	290-0437 (not shown).....	Black Receiver Cap.....	2
19.....	293-1339 (not provided).....	Breakaway Switch.....	1
20.....	294-0805 (not provided).....	4 Pin Connector.....	1
21.....	294-0902 (not provided).....	6 Pin Connector.....	1

## **Important:**

Use only genuine factory replacement parts on your baseplate. Do **NOT** substitute homemade or non-typical parts. If a bolt is lost or in need of replacement, for your safety and the preservation of your baseplate, be sure to use a replacement bolt of the same grade (In most cases it will be Grade 5, please reference the parts list above). Replacement parts may be ordered through your nearest Blue Ox® Dealer or Distributor. Failing to follow and/or altering these installation instructions in either installation or required equipment will void the manufacturer's warranty. Towing behind a non-motorized vehicle will void the warranty.

## BX2671

2009-14 Ford F150 (No Raptor/King Ranch) (Includes EcoBoost)  
2015-17 Ford Expedition, Lincoln Navigator (Includes EcoBoost & ACC)  
2015-18 Ford F150 (Includes EcoBoost & ACC)  
2016-18 Ford F150 Raptor (Includes ACC)  
Installation Instructions

### \* 2009-14 F-150 Bumper Removal \*



1. Using a 15MM socket, remove the nut in front of the lower valance. Do this on both sides of the vehicle.

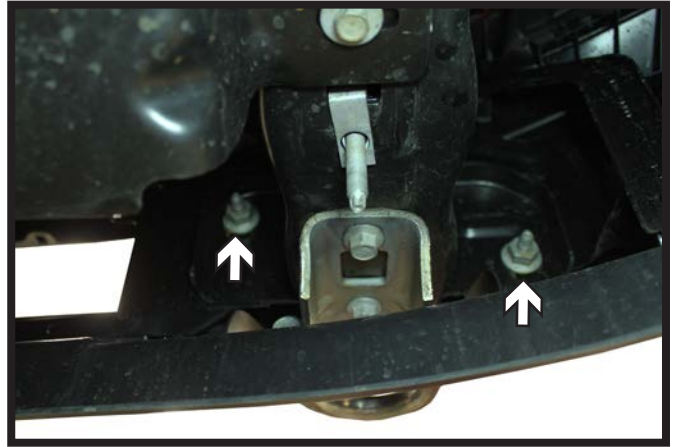

2. Using a 21MM socket, remove the two (2) nuts from the backside of the bumper. Do this on both sides of the vehicle.

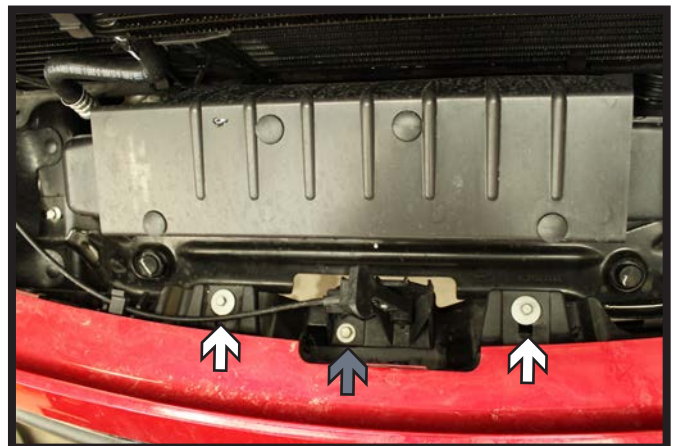
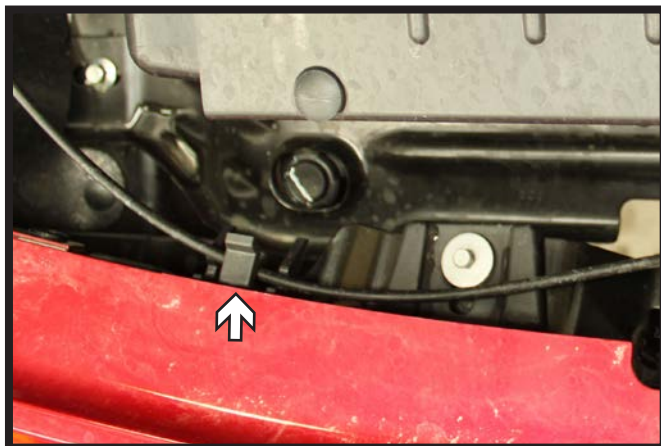

3. Unclip the cable from the clamp on the passenger side (left). Using a 8MM socket, remove the two (2) bolts from the middle of the bumper (right-white). Then using a 10MM socket, remove the center bolt from the middle of the bumper (right-gray). Remove the bumper from the vehicle disconnecting any electrical connections and set aside.

continue to page 9 for baseplate installation

## BX2671

2009-14 Ford F150 (No Raptor/King Ranch) (Includes EcoBoost)  
2015-17 Ford Expedition, Lincoln Navigator (Includes EcoBoost & ACC)  
2015-18 Ford F150 (Includes EcoBoost & ACC)  
2016-18 Ford F150 Raptor (Includes ACC)  
Installation Instructions

### \* Expedition Fascia Removal \*



1. Using a Phillips screwdriver, remove the twelve (12) push pins from the top edge of the fascia cover. There are six (6) on each side. Set the cover aside.

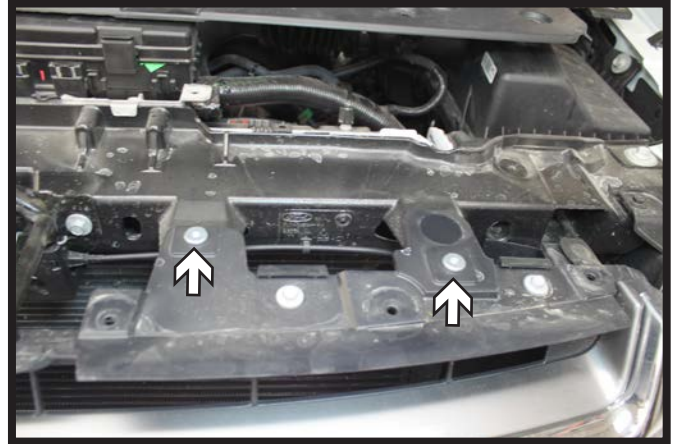

2. Using a T30 Torx, remove the four (4) screws from the top edge of the grille. There are two (2) on each side.



3. Using a 7MM socket, remove the three (3) screws from the edge of the wheel well. Do this on both sides of the vehicle.

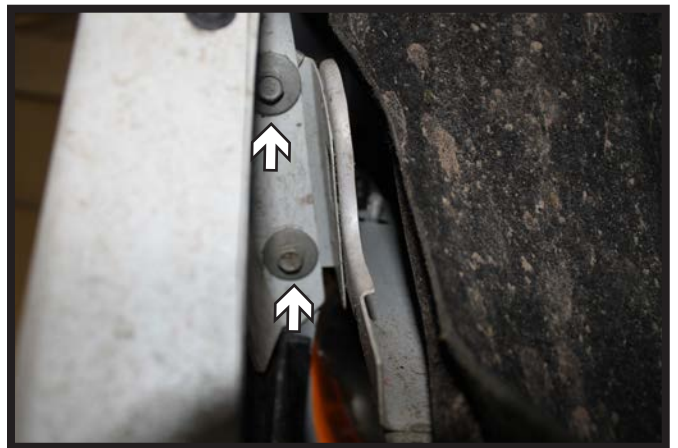

4. Using a 10MM socket, remove the two (2) screws from inside edge of the fascia/fender joint. Do this on both sides of the vehicle.

Pull the corners of the fascia away from the vehicle disconnecting any electrical connections and set the fascia aside.

continue to page 9 for baseplate installation

## BX2671

2009-14 Ford F150 (No Raptor/King Ranch) (Includes EcoBoost)  
2015-17 Ford Expedition, Lincoln Navigator (Includes EcoBoost & ACC)  
2015-18 Ford F150 (Includes EcoBoost & ACC)  
2016-18 Ford F150 Raptor (Includes ACC)  
Installation Instructions

### \* 2015-18 F-150 Bumper Removal \*



1. Unsnap the plastic cover from the face of the bumper. Do this on both sides of the vehicle.



2. If equipped with Adaptive Cruise, using a 11MM socket, remove the three (3) nuts from the ACC sensor. Unsnap the sensor, disconnect the electrical connection and set aside.



3. On the backside of the bumper, using a 21MM socket, remove the nut on the outside of the frame. Do this on both sides of the vehicle.

Directly center of the bumper, remove the push pin at the bumper/lower valance joint (inset).

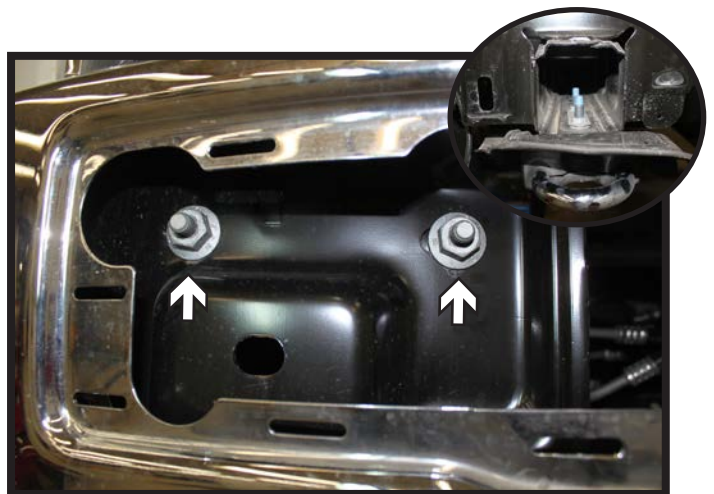

4. Using a 21MM socket, remove the two (2) nuts from the face of the bumper. Do this on both sides of the vehicle.

Disconnect any electrical connections and set the bumper aside.

Remove the plastic shields from around the tow hooks (inset).

continue to page 9 for baseplate installation

## BX2671

2009-14 Ford F150 (No Raptor/King Ranch) (Includes EcoBoost)  
2015-17 Ford Expedition, Lincoln Navigator (Includes EcoBoost & ACC)  
2015-18 Ford F150 (Includes EcoBoost & ACC)  
2016-18 Ford F150 Raptor (Includes ACC)  
Installation Instructions

### \* 2016-17 F-150 Raptor Bumper Removal \*



1. Unsnap the plastic cover from the face of the bumper. Do this on both sides of the vehicle.

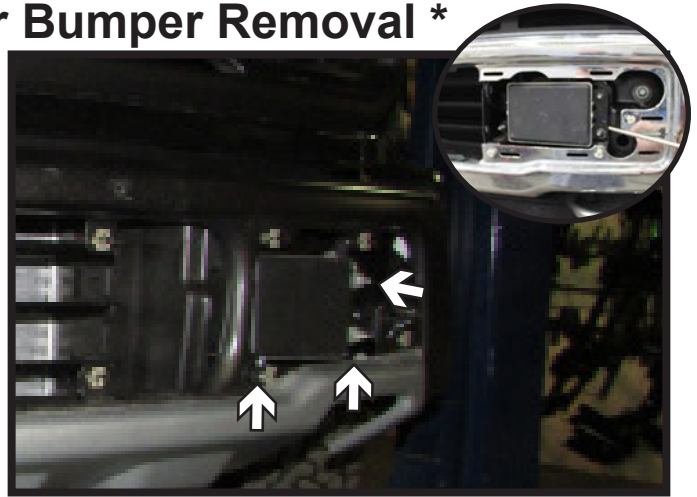

2. If equipped with Adaptive Cruise, using a 11MM socket, remove the three (3) nuts from the ACC sensor. Unsnap the sensor, disconnect the electrical connection and set aside.

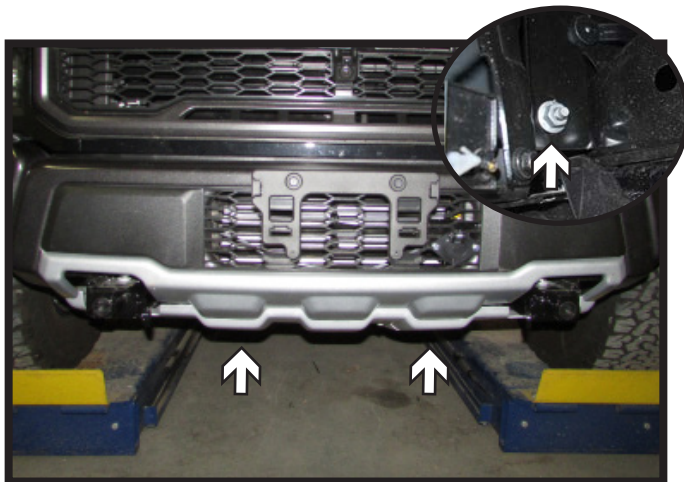

3. Using a 15MM socket remove the six (6) bolts holding the skid plate.  
Then on the backside of the bumper, using a 21MM socket, remove the nut on the outside of the frame. Do this on both sides of the vehicle.

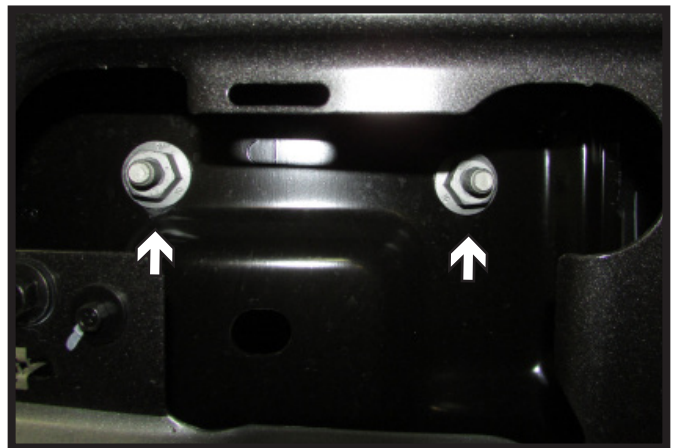

4. Using a 21MM socket, remove the two (2) nuts from the face of the bumper. Do this on both sides of the vehicle.  
Disconnect any electrical connections and set the bumper aside.  
Remove the plastic shields from around the tow hooks (inset).

continue to page 9 for baseplate installation



## BX2671

2009-14 Ford F150 (No Raptor/King Ranch) (Includes EcoBoost)  
2015-17 Ford Expedition, Lincoln Navigator (Includes EcoBoost & ACC)  
2015-18 Ford F150 (Includes EcoBoost & ACC)  
2016-18 Ford F150 Raptor (Includes ACC)  
Installation Instructions

### \* Navigator Fascia Removal \*

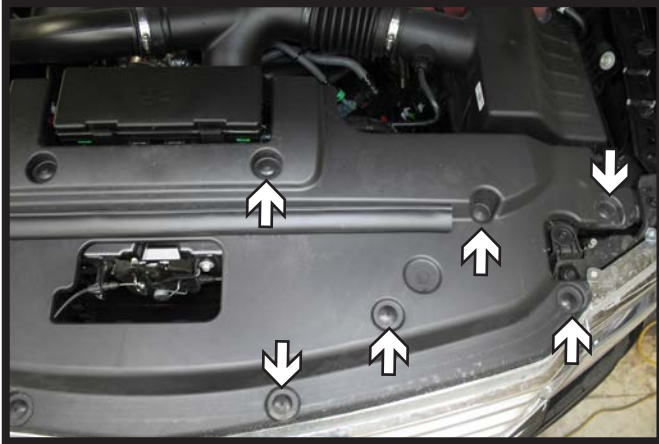

1. Using a Phillips screwdriver, remove the twelve (12) push pins from the top edge of the fascia cover. There are six (6) on each side. Set the cover aside.



2. Using a T30 Torx, remove the four (4) screws from the top edge of the grille (gray). There are two (2) on each side. Using a 10MM socket, remove the outer fascia screw (white). Do this on both sides of the vehicle. On the passenger side only, remove the two (2) hood latch screws.

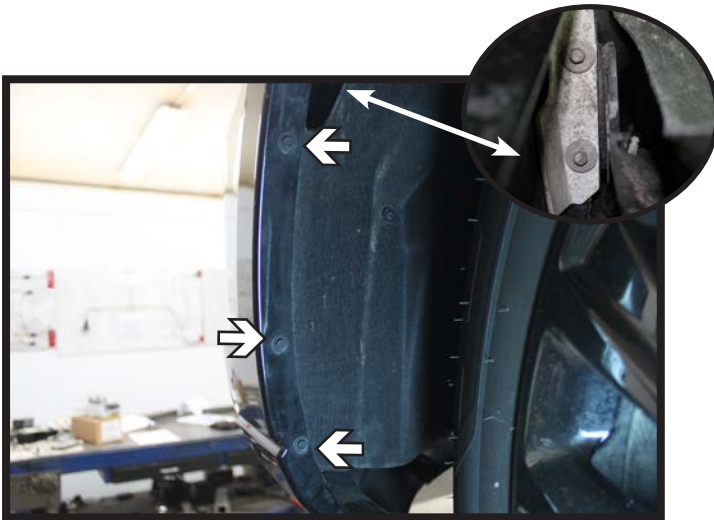

3. Using a 10MM socket, remove the three (3) screws from the edge of the wheel well. Along with the two (2) screws up inside the wheel well along the fascia joint. Do this on both sides of the vehicle.



4. On the underside of the fascia towards the middle, remove the two (2) push pins. Pull the corners of the fascia away from the vehicle disconnecting any electrical connections and set the fascia aside.

continue to page 9 for baseplate installation

## BX2671

2009-14 Ford F150 (No Raptor/King Ranch) (Includes EcoBoost)  
2015-17 Ford Expedition, Lincoln Navigator (Includes EcoBoost & ACC)  
2015-18 Ford F150 (Includes EcoBoost & ACC)  
2016-18 Ford F150 Raptor (Includes ACC)

Installation Instructions

### \* Baseplate Installation \*

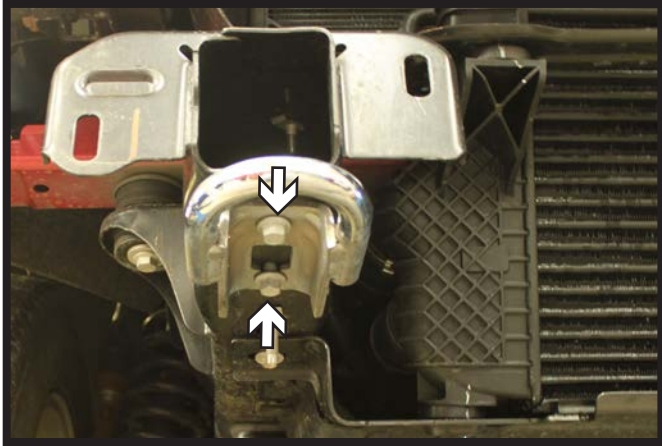

1. Using a 15MM socket, remove the two (2) bolts from the tow hook. Do this on both sides of the vehicle. Do not discard the existing hardware.

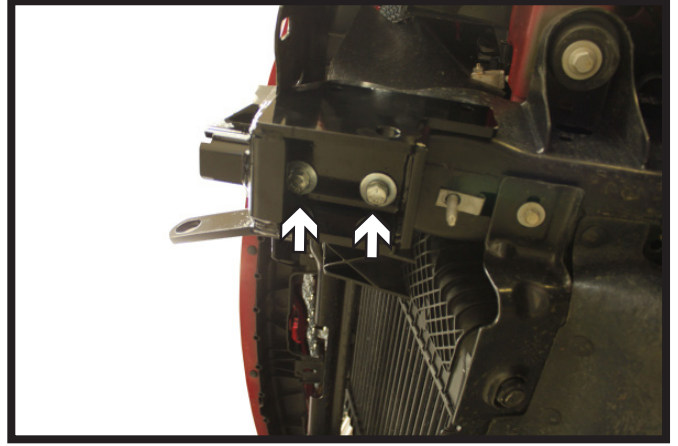

2. Install the baseplate to the frame with the existing hardware. Do this on both sides of the vehicle. Fully tighten all fasteners. (Note: If tow hooks are not present, use the supplied hardware for baseplate installation.) (Note: Ensure that the outer side plate is tight against the frame.)

\*\* Use Loctite® Red on all bolt threads and tighten all bolts to the appropriate torque.

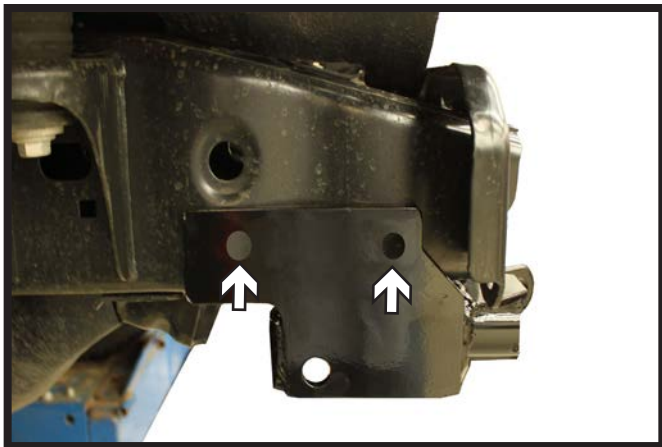

3. Using a 17/32" drill bit, drill the existing holes thru the frame. Install 1/2"-13 x 1-3/4" bolts with lock washers into the holes with 1/2"-13 nut plates on the inside of the frame. Do this on both sides of the vehicle. Fully tighten all hardware.



4. Attach the permanent baseplate safety cables to the provided convenience link on the baseplate. The photo above shows the recommended installation of the cables to frame of vehicle. Additional options may interfere with suggested mounting; in this case, secure the cables to a solid piece of the frame as described in the instructions included with the permanent baseplate safety cables. Be sure the safety cables do not rub against any hoses or moving parts. Do this on **BOTH** sides of the vehicle.

\*\* Use Loctite® Red on all bolt threads and tighten all bolts to the appropriate torque.

## BX2671

2009-14 Ford F150 (No Raptor/King Ranch) (Includes EcoBoost)  
2015-17 Ford Expedition, Lincoln Navigator (Includes EcoBoost & ACC)  
2015-18 Ford F150 (Includes EcoBoost & ACC)  
2016-18 Ford F150 Raptor (Includes ACC)  
Installation Instructions

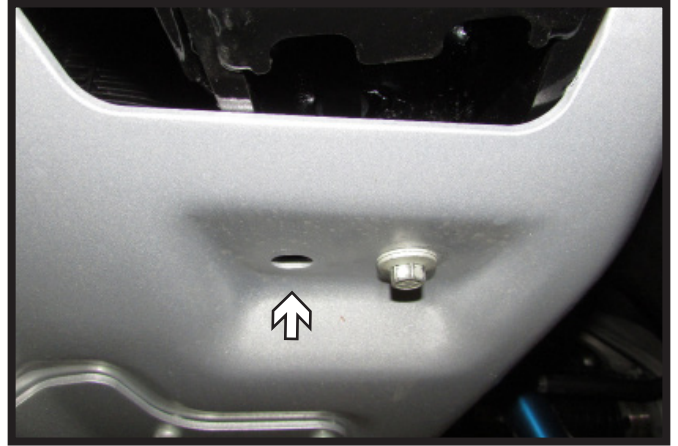

5. Reinstall the ACC sensor if removed. Reinstall the bumper or fascia/fascia cover.

Note: For 2017 Ford F150 Raptor application the front two (2) inside bolts, one (1) on each side, will not be used to reinstall skid plate (see image on right side).

### CUSTOMER SERVICE COMMITMENT

Blue Ox® is committed to providing you with exceptional customer care throughout your lifetime with our products. Our team is here to assist you with any questions you may have regarding the performance of your product. Simply call (402) 385-3051 and you can speak with our technical service team.

Additionally, please visit our website to see which rallies our Destination America team will be attending. For a nominal fee, our service technician will service your towing system to ensure it's in proper working condition. Also, as a commitment to our customers, should you visit our factory, you can stay at our full service Blue Ox® campground at no charge along with enjoying a factory tour.

Again, thank you for being our customer and for the confidence you have shown in the performance of our products. It is because of customers like you we enjoy the success we have today.

© 2015 Blue Ox  
One Mill Road, Industrial Park  
Pender, Nebraska 68047  
Phone: (402) 385-3051  
Fax: (402) 385-3360  
www.blueox.com

# General Information

1. Ensure that your product(s) are registered online at [www.blueox.com](http://www.blueox.com). It is crucial to register your product(s) so that you may be alerted of product offerings, updates, upgrades, maintenance and safety bulletins, and/or recalls.
2. **It is the owner's responsibility to inspect all towing equipment for cracked welds, missing or worn parts and loose bolts before each towing trip.** Be sure to use Loctite® Red on all bolts and tighten to the recommended specifications.
3. **It is the owner's responsibility to hook up all towing equipment per manufacturer's instructions/recommendations.**
4. Remove the attachment tabs when not in use (if applicable).

## Notice To Baseplate Installer

### 1. It is YOUR responsibility to watch for:

- Oil cooler and air conditioner lines
- Electrical wires and hoses
- Missing parts or attaching points on the frame

\*\* If the baseplate is improperly installed and is against a wire or hose, it could cause fluid leaks or electrical shorts some time after the actual baseplate installation.

## Permanent Baseplate Safety Cable Installation

Permanent baseplate safety cables are strongly recommended when towing a vehicle with a tow bar. The principle function of the permanent baseplate safety cables is to prevent the towed vehicle from breaking loose in the event the connection between the frame of the towed vehicle and the baseplate fails or becomes disconnected. The cables must be connected from the baseplate to the frame rail or cross member of the vehicle's frame. The illustrations below show the possible arrangements recommended by Blue Ox®. Each permanent baseplate safety cable must have an adequate weight rating for the towing system. The weight rating of the two (2) cables together will not qualify.

***Do not mount the permanent baseplate safety cables against wires, hoses or brake lines.***

These permanent baseplate safety cables should remain installed as long as the baseplate is installed on the vehicle. Permanent baseplate safety cables are to be used in conjunction with, and NOT a replacement for legally required safety cables attaching the towed vehicle to the towing vehicle.

### Option #1

(Baseplates with Convenience Link Tabs)

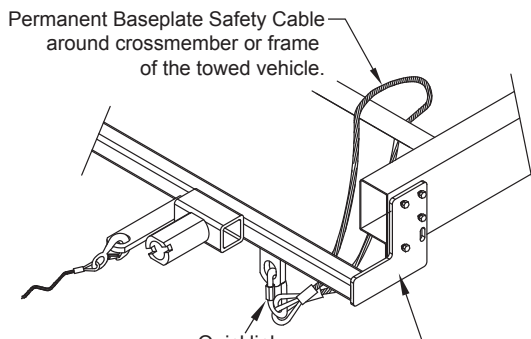

### Option #2

(Baseplates with out Convenience Link Tabs)

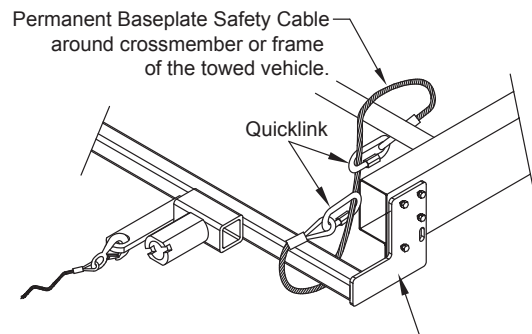

# BLUE OX ORIGINAL PURCHASERS THREE YEAR LIMITED WARRANTY

Automatic Equipment Manufacturing Company ("Automatic") warrants to the original (first) retail purchaser that this product, manufactured by Automatic, shall be free from defect in material and workmanship under normal use and service for a period of three years from the date of delivery.

During said three-year period, Automatic will repair or replace any parts that have been returned by the original purchaser, to the factory, transportation prepaid, and in Automatic's sole and absolute opinion found to be defective.

Limitations on Warranty Coverage:

Coverage under this warranty will be valid only if the customer warranty card is returned by the original purchaser within 30 days of purchase.

Coverage under this warranty will be effective only when a copy of the original invoice, showing date and place of purchase, accompanies any claim for warranty. This warranty is NON TRANSFERABLE.

This limited warranty will not cover, in any way or form, any alleged damages caused by incorrect or improper installation, improper use, modification or neglect of product, failure to properly service and maintain, misuse, act of God, accident or failure of the user to follow guidelines contained in the instructional material provided by Automatic.

This warranty does not cover normal wear and tear, paint or rust.

Warrantor assumes no responsibility to the owner for loss of use of product, loss of time, inconvenience or any other damage consequential or otherwise. Including, but not limited to mileage, expense of transporting of product, return shipping expense, mechanics travel time, telephone, road service, towing, and rental during repairs, travel, lodging, loss or damage to personal property or loss of earnings.

**REPAIR OR REPLACEMENT AS SET FORTH IN THIS LIMITED WARRANTY IS THE SOLE EXCLUSIVE REMEDY OF THE PURCHASER. AUTOMATIC SHALL NOT BE LIABLE FOR ANY INCIDENTAL OR CONSEQUENTIAL DAMAGES FOR BREACH OF ANY EXPRESS OR IMPLIED WARRANTY ON THIS PRODUCT. EXCEPT TO THE EXTENT PROHIBITED BY APPLICABLE LAW, ANY IMPLIED WARRANTY OF MERCHANTABILITY OR FITNESS FOR A PARTICULAR PURPOSE ON THIS PRODUCT IS LIMITED IN LENGTH TO THE DURATION OF THIS WARRANTY.**

Please visit <http://blueox.com/warranty/> to register your warranty

