



BX2330

2011-12 Hyundai Sonata (No Foglights) Installation Instructions

Serial Number

Please read **BOTH** these Installation Instructions and the General Instructions before attempting to install or operate this equipment.

- Blue Ox® towing products and accessories are intended to be installed by Blue Ox® Dealers who are familiar with our products and have the equipment and knowledge to do “fit work”. When necessary Blue Ox® Dealers can be found at www.blueox.com or by contacting our Customer Care Department at (402) 385-3051.
- Many Blue Ox® Baseplates are designed to use existing holes and hardware to mount the baseplate to the towed vehicle. Even though bolts are there, do not assume they are adequate for baseplate mounting. Always use hardware supplied in the hardware kit or existing hardware specified in the Baseplate Towing Installation Instructions.

Attachment Tab Height: 13”

Attachment Tab Width: 24”

Bolt Torque Specifications
Torque in Foot-Pounds for Metric Bolts

Bolt Size	Grade 8.8	Grade 10.9
6MM	6	8
8MM	16	22
10MM	31	40
12MM	54	70
14MM	89	117

Confirm the towability and pre-towing procedures for your vehicle with the owner’s manual or contact the vehicle’s manufacturer for specific towing procedures.

Bolt Torque Specifications
Torque in Foot-Pounds for Inch Bolts

Bolt Size	Grade 5	Grade 8
1/4”	10	14
5/16”	19	29
3/8”	33	47
7/16”	54	78
1/2”	78	119
5/8”	154	230



If the front of your vehicle looks different than this, call us at (402) 385-3051.

⚠ WARNING

Failure to read and follow these instructions could result in separation of the towed vehicle from the tow bar, causing property damage, loss of towed vehicle, personal injury or death.



BX2330

2011-12 Hyundai Sonata (No Foglights) Installation Instructions

Item No.	Part No.	Description	Qty.
1	61-5208	3/8"-16 Nut Plate with 14" Wire	6
2	61-6815	BX2330 Baseplate	1
3	62-3468	Attachment Tab	2
4	101-5822	4 Way Connector Adapter	2
5	102-7123	BX2330 4" Flat	1
6	102-7124	BX2330 Breakaway Bracket	1
7	201-0050	1/4"-20 x 3/4" Hex head Bolt, Grade 5, ZP	3
8	201-0192	#10-32 1/2" Round Slotted Head Screw	2
9	201-0368	3/8"-16 x 1-1/4" Hex Head Bolt, Grade 5, ZP	10
10	201-0979	#12-14 x 1" Self Drilling Screw, ZP	2
11	202-0047	#10-32 Hex Nut	2
12	202-0090	3/8"-16 Hex Nylon Insert Lock Nut, ZP	4
13	202-0102	1/4"-20 Hex Nylon Nut, ZP	3
14	203-0008	1/4" Lock Washer, ZP	3
15	203-0010	3/8" Lock Washer, ZP	10
16	203-0054	#10 Lock Washer	2
17(not shown)	226-0046	36" Class III Safety Cables	2
18(not shown)	229-0359	3/8" Quicklink, ZP	2
19(not provided)	293-1339	Breakaway Switch	1
20(not provided)	294-0805	4 Pin Connector	1
21(not provided)	294-0902	6 Pin Connector	1

Tools Required

- 8MM Socket
- 10MM Socket
- 12MM Socket/Wrench
- 13MM Socket
- 9/16" Socket
- Large Vise Grip
- Reciprocating Saw
- Drill
- Flat Screw Driver
- Phillips Screw Driver
- Utility Knife
- Torque Wrench
- Tape Measure
- 13/32" Drill Bits
- Loctite® RED

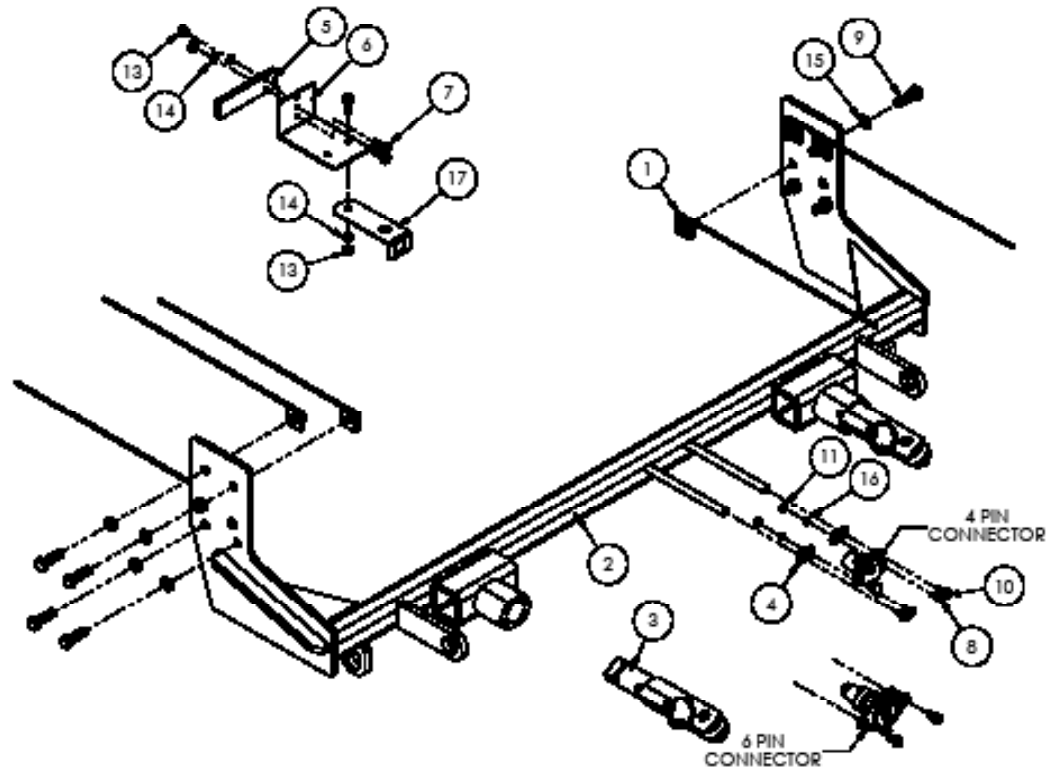

Important:

Use only genuine factory replacement parts on your baseplate. Do **NOT** substitute homemade or non-typical parts. If a bolt is lost or in need of replacement, for your safety and the preservation of your baseplate, be sure to use a replacement bolt of the same grade (In most cases it will be Grade 5, please reference the parts list above). Replacement parts may be ordered through your nearest Blue Ox® Dealer or Distributor. Failing to follow and/or altering these installation instructions in either installation or required equipment will void the manufacturer's warranty. Towing behind a non-motorized vehicle will void the warranty.



BX2330

2011-12 Hyundai Sonata (No Foglights) Installation Instructions

Attachment Tabs:

Due to the design of the removable tabs, the RangeFinderII tow bar can not be used. Adapters, except the BX8833 and BX88151, can not be used with this baseplate.

Instructions:

The front fascia, and washer reservoir are removed for the baseplate installation. Drilling is required. Trimming of the frame and air dam is required.

The dimensional variations between otherwise identical vehicles can be considerable. While the baseplate was designed for easy installation, it may be necessary to tailor the baseplate slightly to compensate for auto manufacturer's tolerances. These minor adjustments may include filing a hole slightly, bending electrical rods or bending end plates.

The BX8869 Bulb and Socket Wiring Kit is available for this vehicle.



Possible Location of the BX8869 Bulb & Socket Wiring Kit

Installation Instructions:



1. Just forward of front tire, on the edge of the wheel well remove the bolt with a 10MM socket or a Phillips screw driver, both sides.



2. Just forward of front tire on the lower edge of the fascia are two Phillips push pins to remove with the Phillips screw driver, both sides.

Handling of some cosmetic parts when installing this product may require the use of protective covers, rags, specialty tools, etc. to prevent damage.

BX2330

2011-12 Hyundai Sonata (No Foglights) Installation Instructions



3. Remove the metric bolt from the corner of the top edge of the fascia, just above the headlight with a 10MM socket, both sides.



4. Remove the six Phillips push pins from the top of the fascia.



5. Pull fascia's corner out to the side to release the clips, pull fascia forward both sides, unplug all electrical components if necessary and set fascia aside carefully.



6. On the driver's side, press the button on the side of the coax junction to loosen. Unclip from the back three christmas tree pins and move out of the way.

2011-12 Hyundai Sonata
(No Foglights)
Installation Instructions

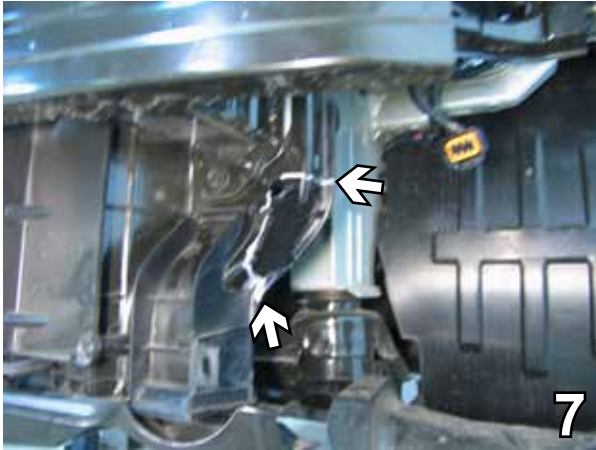

7. Using a reciprocating saw cut straight across the top of the hole and on the inside edge of the hole straight down. Do this on both sides.



8. On the passenger side, unplug the hoses from the washer reservoir and cap. Using a 10MM socket, remove one bolt on each side. Pull the washer reservoir off and set aside to be reinstalled later.

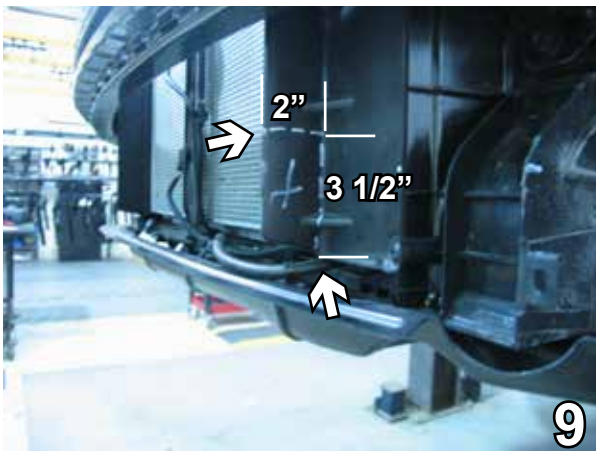

9. Mark a line on the inner edge of the air dam, 3 1/2" up from the bottom edge and cut straight up the crease. Cut straight out 2" to the edge. Remove this area with the reciprocating saw, both sides.

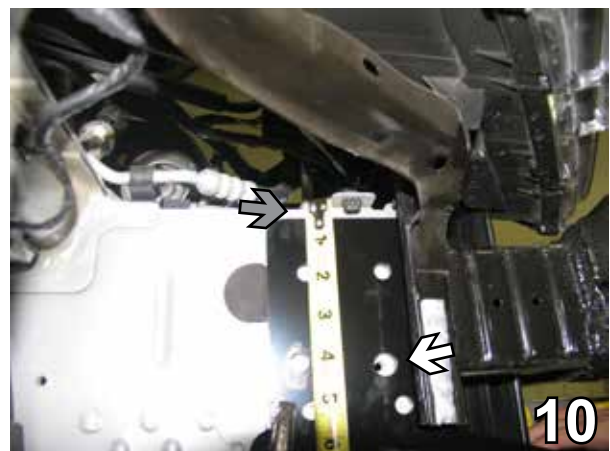

10. Slide the baseplate on to the frame rail to align with the existing hole for the washer reservoir on the passenger's side, and clamp the baseplate to the frame rail on both sides with the vise grip. Baseplate should measure 1/2" from the top of the frame ribbing down to the top edge of baseplate and as far forward as possible, both sides.



BX2330

2011-12 Hyundai Sonata (No Foglights) Installation Instructions

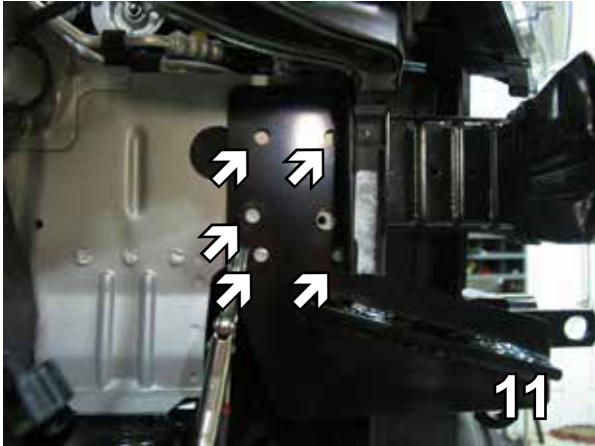

11. Using the baseplate as a template, drill five holes with the 13/32" drill bit.

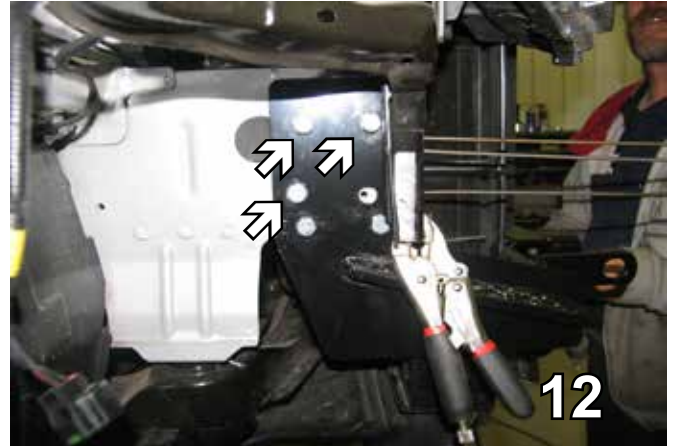

12. Insert the nut plates into the end of frame rail, just behind metal bumper bracket to align with the top three drilled holes, insert 3/8-16 x 1 1/4" hex bolts and 3/8" lock washers into baseplate drilled holes with the 9/16" socket, both sides. Be sure to use Loctite on all bolts.

When using power drills be aware of the dangers of torque and drill bit length.

BE SURE TO USE LOCTITE® RED ON ALL BOLTS BEFORE TIGHTENING. TIGHTEN ALL BOLTS ACCORDING TO THE TORQUE CHART ON THE FRONT PAGE OF THESE INSTRUCTIONS OR ON PAGE 3 OF THE BASEPLATE GENERAL TOWING INSTRUCTIONS.

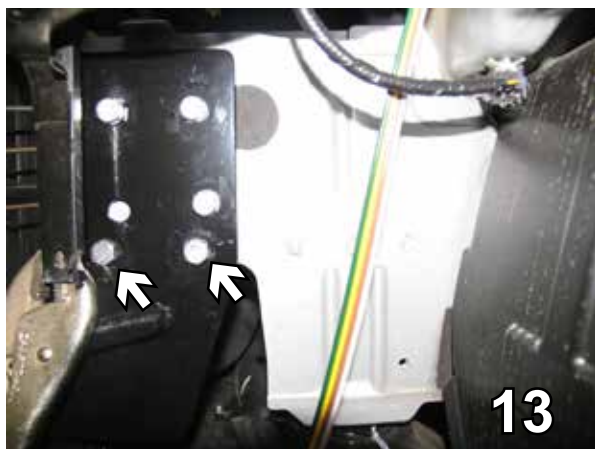

13. Insert 3/8-16 x 1 1/4" hex bolts and 3/8" lock washers into baseplate bottom two holes to align with 3/8-16 lock nuts tighten with the 9/16" socket, both sides. Be sure to use Loctite on all bolts.



14. Attach the permanent baseplate safety cables to the provided convenience link on the baseplate (see grey arrow). The photo above shows the recommended installation of the cables to frame of vehicle (see white arrow). Additional options may interfere with suggested mounting; in this case secure the cables to a solid piece of the frame as described in the instructions included with the permanent baseplate safety cables. Be sure the safety cables do not rub against any hoses or moving parts. Do this to both sides of the vehicle.



BX2330

2011-12 Hyundai Sonata (No Foglights) Installation Instructions



15. Reinstall the washer reservoir on the passenger side, using the existing bolts. Be sure that all the electrical connections and hoses are plugged in properly.

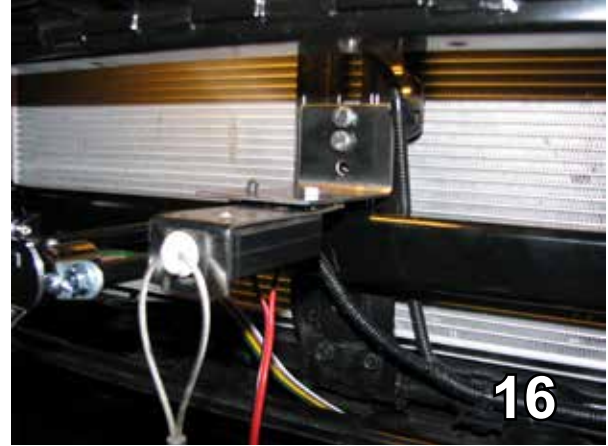

16. Position the flat behind the breakaway bracket and attach with 1/4-20 x 3/4" bolts and 1/4" lock washers. Reinstall fascia. **Be sure all electrical components are plugged in properly.**



17. Location for the 4 or 6 pin electrical coupler on the fascia's lower air dam just below license plate.

Be sure that ALL electrical connections are plugged in properly and functioning BEFORE Installing the fascia.

18. The dimensional variations between otherwise identical cars can be considerable. While the baseplate was designed for easy installation, it may be necessary to tailor the baseplate slightly to compensate for auto manufacturers' tolerances. These minor adjustments may include filing a hole slightly, bending electrical rods, adding and/or bending endplates.
19. Install the tow bar and safety cables according to the instructions included in their packages.
20. Do **not** substitute other devices if the tow bar pin and clip are lost.
- 21. DEALER OR INSTALLER: BE CERTAIN THE USER RECEIVES THE INSTRUCTION SHEET.**



BX2330

2011-12 Hyundai Sonata (No Foglights) Installation Instructions

DEALER or INSTALLER:

Be certain the user receives the instruction sheets for their products.



Shown without Removable Tabs Installed.

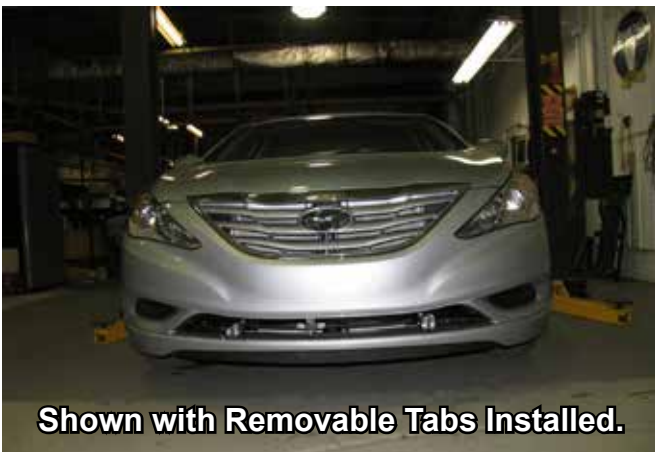

Shown with Removable Tabs Installed.

If the baseplate is in an accident, it must be replaced. DO NOT use it again! An accident can cause unseen damage and using it again could result in more damage or serious injury. DO NOT use the baseplate if it is damaged or missing parts.

CUSTOMER SERVICE COMMITMENT

Blue Ox is committed to providing you with exceptional customer care throughout your lifetime with our products. Our team is here to assist you with any questions you may have regarding the performance of your product. Simply call (402) 385-3051 and you can speak with our customer care team.

Additionally, please visit our website to see which rallies our Destination America team will be attending. For a nominal fee, our service technician will service your towing system to ensure it's in proper working condition. Also as a commitment to our customers, should you visit our factory you can stay at our full service Blue Ox campground at no charge along with enjoying a factory tour.

Again thank you for being our customer and for the confidence you have shown in the performance of our products. It is because of customers like you we enjoy the success we have today.



© 2010 Blue Ox
One Mill Road, Industrial Park
Pender, Nebraska 68047
Phone: (402) 385-3051
Fax: (402) 385-3360
www.blueox.com
4/24/12

General Information

1. Ensure that your product(s) are registered online at www.blueox.com. It is crucial to register your product(s) so that you may be alerted of product offerings, updates, upgrades, maintenance and safety bulletins, and/or recalls.
2. **It is the owner's responsibility to inspect all towing equipment for cracked welds, missing or worn parts and loose bolts before each towing trip.** Be sure to use Loctite® Red on all bolts and tighten to the recommended specifications.
3. **It is the owner's responsibility to hook up all towing equipment per manufacturer's instructions/recommendations.**
4. Remove the attachment tabs when not in use (if applicable).

Notice To Baseplate Installer

1. It is YOUR responsibility to watch for:

- Oil cooler and air conditioner lines
- Electrical wires and hoses
- Missing parts or attaching points on the frame

** If the baseplate is improperly installed and is against a wire or hose, it could cause fluid leaks or electrical shorts some time after the actual baseplate installation.

Permanent Baseplate Safety Cable Installation

Permanent baseplate safety cables are strongly recommended when towing a vehicle with a tow bar. The principle function of the permanent baseplate safety cables is to prevent the towed vehicle from breaking loose in the event the connection between the frame of the towed vehicle and the baseplate fails or becomes disconnected. The cables must be connected from the baseplate to the frame rail or cross member of the vehicle's frame. The illustrations below show the possible arrangements recommended by Blue Ox®. Each permanent baseplate safety cable must have an adequate weight rating for the towing system. The weight rating of the two (2) cables together will not qualify.

Do not mount the permanent baseplate safety cables against wires, hoses or brake lines.

These permanent baseplate safety cables should remain installed as long as the baseplate is installed on the vehicle. Permanent baseplate safety cables are to be used in conjunction with, and NOT a replacement for legally required safety cables attaching the towed vehicle to the towing vehicle.

OPTION #1

Permanent Baseplate Safety Cables to Cross Member or Frame of Towed Vehicle.



OPTION #2

Permanent Baseplate Safety Cables to Cross Member or Frame of Towed Vehicle.

