



BX2329

2010-15 Hyundai Tucson Installation Instructions

Attachment Tab Height: 16-1/2"

Attachment Tab Width: 24"

Serial Number

Please read BOTH these Installation Instructions and the General Instructions prior to installing or operating this equipment.

- Blue Ox® towing products and accessories are intended to be installed by Blue Ox® Dealers who are familiar with our products and have the equipment and knowledge necessary to do "fit work". If needed, Blue Ox® Dealers can be found at www.blueox.com or by contacting our Customer Care Department at (402) 385-3051.
- Many Blue Ox® baseplates are designed to use existing holes and hardware to mount the baseplate to the towed vehicle. Even though bolts are there, do not assume they are adequate for baseplate mounting. Always use the hardware supplied in the hardware kit and existing hardware as specified in the installation instructions.



If the front of your vehicle looks different than this, please contact us at (402)385-3051.

Reference your vehicle owner's manual for manufacturer's towing specifications.

Bolt Torque Specifications

Torque in Foot-Pounds for Inch Bolts

Bolt Size	Grade 5	Grade 8
1/4"	10	14
5/16"	19	29
3/8"	33	47
7/16"	54	78
1/2"	78	119
5/8"	154	230
3/4"	257	380

Bolt Torque Specifications

Torque in Foot-Pounds for Metric Bolts

Bolt Size	Grade 8.8	Grade 10.9
6MM	6	8
8MM	16	22
10MM	31	40
12MM	54	70
14MM	89	117
16MM	161	230
18MM	222	318



WARNING

Failure to read and follow these instructions could result in separation of the towed vehicle from the tow bar, causing property damage, loss of towed vehicle, personal injury or death.

BX2329
2010-15 Hyundai Tucson
Installation Instructions

Instruction Notes: The fascia and windshield washer fluid reservoir are removed and reinstalled for the baseplate installation. Some drilling and trimming is required.

Place all components that are removed on a flat, sturdy surface. All items will be reinstalled unless otherwise noted after the baseplate is installed.

The dimensional variations between otherwise identical vehicles can be considerable. While the baseplate was designed for easy installation, it may be necessary to tailor the baseplate slightly to compensate for vehicle manufacturer's tolerances.

The BX8869 Tail Light Wiring Kit is recommended for this vehicle.



Drill a hole according to the tail
light wiring kit instructions.

NOTICE

- Handling of some cosmetic parts when installing this product may require the use of protective covers, rags, specialty tools, etc. to prevent damage.
- When using power drills be aware of the dangers of torque and drill bit length.
- When using a reciprocating saw be aware of objects behind the cutting surface.
- Use a good quality paint to spray cut edges of frame to prevent rusting.
- Be sure that **ALL** electrical connections are plugged in and accessories are functioning properly before reinstalling the fascia.
- The baseplate is computer tested to your vehicle's GVWR, exceeding this weight will void the manufacturer's warranty.
- Be sure to use Loctite® Red on all bolts before tightening. Tighten all bolts according to the torque chart provided.
- Dealer or installer be certain the user receives these instruction sheet.
- If the baseplate is in an accident, it must be replaced. **DO NOT** use it again! An accident can cause unseen damage and using it again could result in more damage or serious injury. **DO NOT** use the baseplate if it is damaged or missing parts.

BX2329
2010-15 Hyundai Tucson
Installation Instructions

Tools Required

8MM Socket
12MM Socket
5/16" Nut Driver
Reciprocating Saw

Drill
Phillips Screw Driver
Tape Measure
13/32" Drill Bit

10MM Socket
13/32" Drill Bit
Large Vise Grip
Loctite Red

Flat Screw Driver
Torque Wrench
1 1/4" Hole Saw

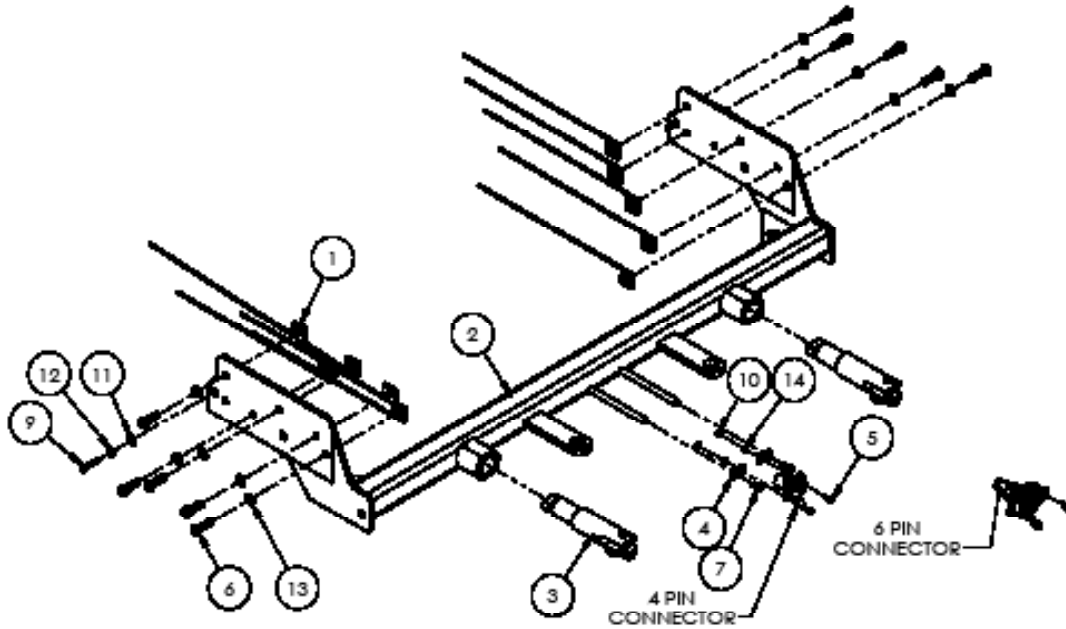

Item No.	Part No.	Description	Qty.
1.....	61-5208	3/8"-16 Nut Plate Weldment with 14" Wire	10
2.....	61-6752	BX2329 Baseplate	1
3.....	62-3468	Attachment Tab with Hole	2
4.....	101-5822	4 Way Connector Adapter.....	2
5.....	201-0192	#10-32 1/2" Round Slotted Head Screw.....	2
6.....	201-0368	3/8"-16 x 1-1/4" Hex Head Bolt, Grade 5, ZP	10
7.....	201-0979	#12-14 x 1" Self Drilling Screw, ZP.....	2
8.....	201-0654	#10-16 x 1" Self Tapping Screw.....	1
9.....	201-0655	6MM-1.0 x 30MM Hex Head Bolt, Grade 8.8, ZP	1
10.....	202-0047	#10-32 Hex Nut.....	2
11.....	203-0002	5/16" Flat Washer, ZP.....	1
12.....	203-0009	5/16" Lock Washer, ZP	1
13.....	203-0010	3/8" Lock Washer, ZP	10
14.....	203-0054	#10 Lock Washer, ZP.....	2
15 (not shown).....	226-0046	36" Class III Baseplate Safety Cable	2
16 (not shown).....	229-0359	3/8" Quicklink , ZP	2
17 (not shown).....	290-0437	Black Cap Plug Receiver	2

Important:

Use only genuine factory replacement parts on your baseplate. Do **NOT** substitute homemade or non-typical parts. If a bolt is lost or in need of replacement, for your safety and the preservation of your baseplate, be sure to use a replacement bolt of the same grade (In most cases it will be Grade 5, please reference the parts list above). Replacement parts may be ordered through your nearest Blue Ox® Dealer or Distributor. Failing to follow and/or altering these installation instructions in either installation or required equipment will void the manufacturer's warranty. Towing behind a non-motorized vehicle will void the warranty.

BX2329
2010-15 Hyundai Tucson
Installation Instructions

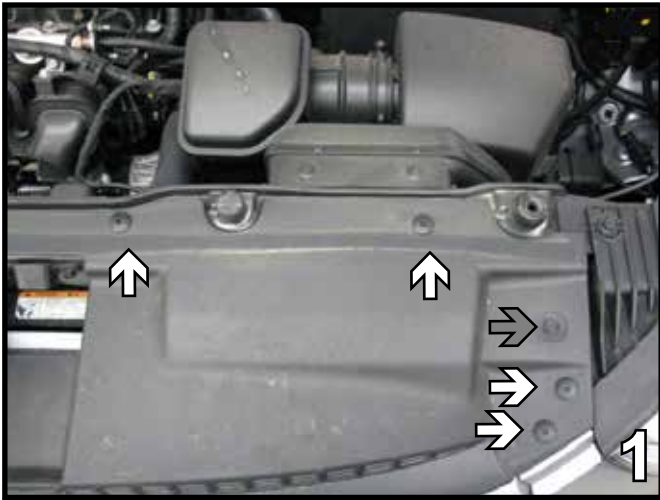

1. Remove the four plastic push pins from the top edge of fascia between head lights (white arrows). Using an 8MM socket, remove one bolt on the side (gray arrow). Do this on both sides of the vehicle.



2. Remove the plastic push pin from lower corner of fascia just forward of front tire. Do this on both sides of the vehicle.



3. Remove the screw on the upper corner of fascia just forward of front tire with the Phillips screw driver. Do this on both sides of the vehicle.



4. Remove the two plastic push pins from underneath the fascia. Do this on both sides of the vehicle.

BX2329
2010-15 Hyundai Tucson
Installation Instructions



5. Underneath the fascia, remove two additional plastic push pins from the middle. Set fascia and pins aside carefully to be reinstalled later.



6. On the passenger side only, unplug the hoses from the washer reservoir and put caps on the water lines. Disconnect the electrical lines.



7. Using the 10MM socket, remove the two metric bolts from the side of the washer reservoir. Set the bolts and the reservoir aside to be reinstalled later.

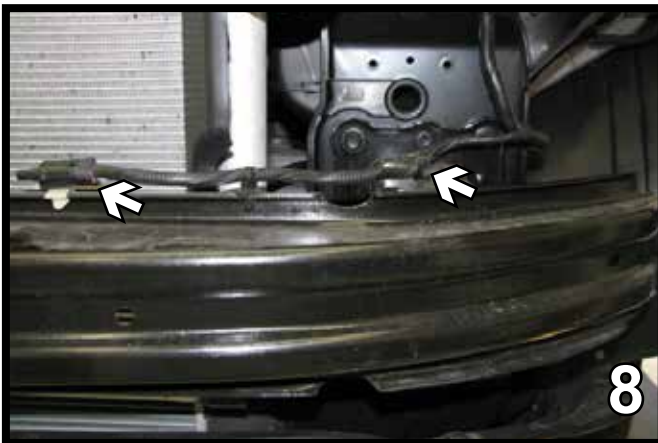

8. Unhook the temperature sensor from the bumper. Set it out of the way while the bumper is removed.

BX2329
2010-15 Hyundai Tucson
Installation Instructions

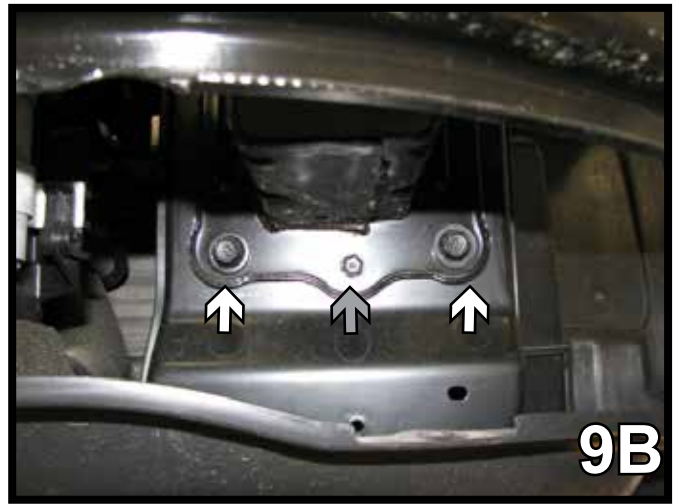
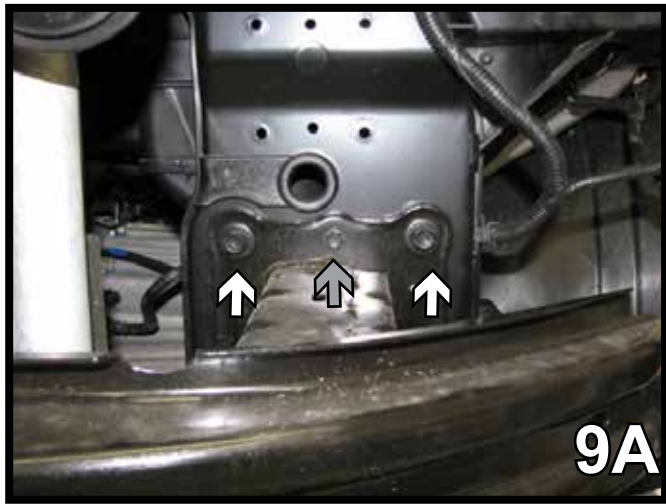

9. Using a 10MM socket, remove the bolt in the center (gray) top and bottom of the bumper bracket. Using a 12MM socket, remove the two outside bolts (white) top and bottom of the bumper bracket. Do this on both sides. Set the bolts and the bumper aside to be reinstalled later.

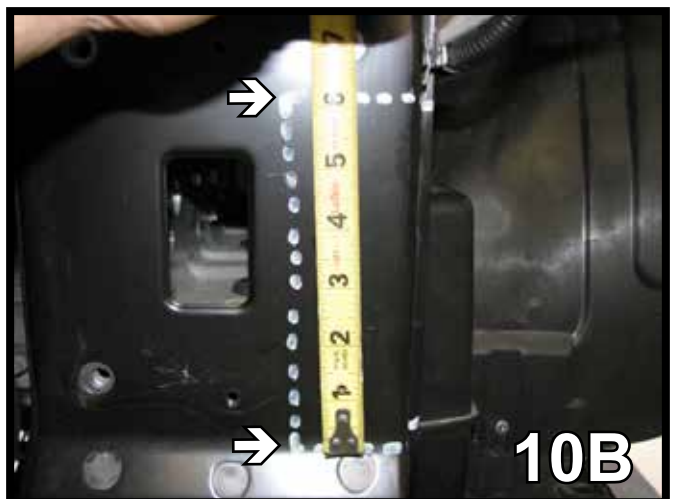
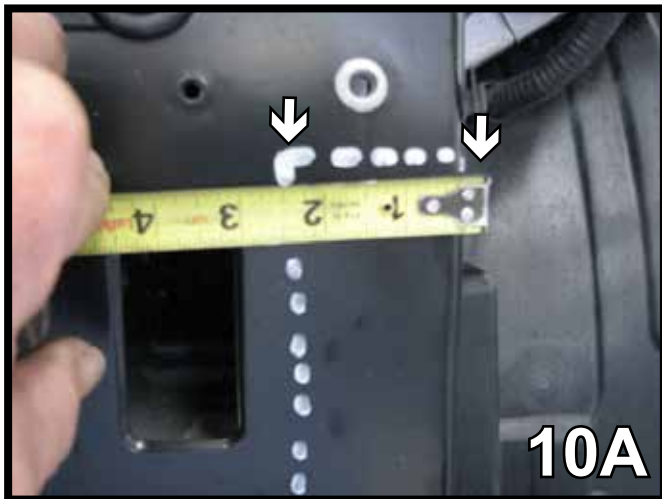

10. Trim on the front side of the frame cap 2 1/2" in toward the center of the vehicle to the outside edge of frame rail. Measure and mark 6 inches down as shown in the right photo. Using the reciprocating saw, make the two horizontal cuts first. The bottom cut should be just above the lip on the backside flush with the bottom edge. Then make the vertical cut flush on the outside edge of the frame rail being careful not to cut into the air baffle. Do this on both sides.

BX2329
2010-15 Hyundai Tucson
Installation Instructions

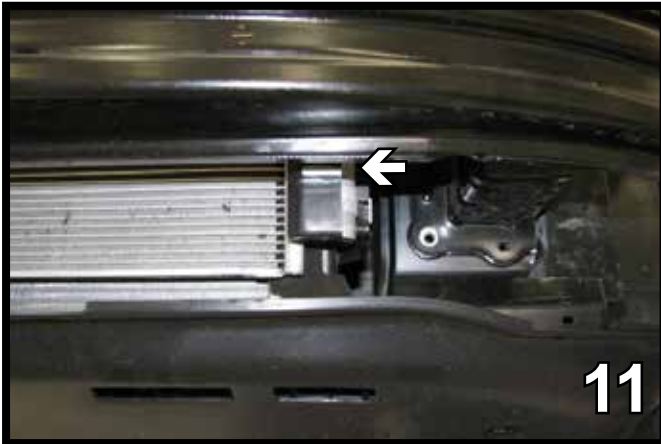

11. Reinstall the bumper. Mark the back side of the bumper on both sides. Remove the bumper and cut as marked. Then reinstall the bumper.



12. Mark 1 3/4" up on the plastic. Remove the piece by pulling out on the backside and lifting up. Cut the marked area. Do this on both sides.

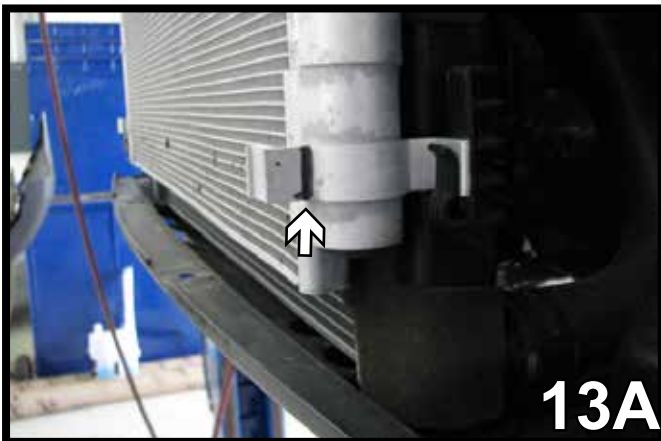

13. Mark then cut off the tabs on each side of the radiator. Reinstall the plastic guard removed in step 12.

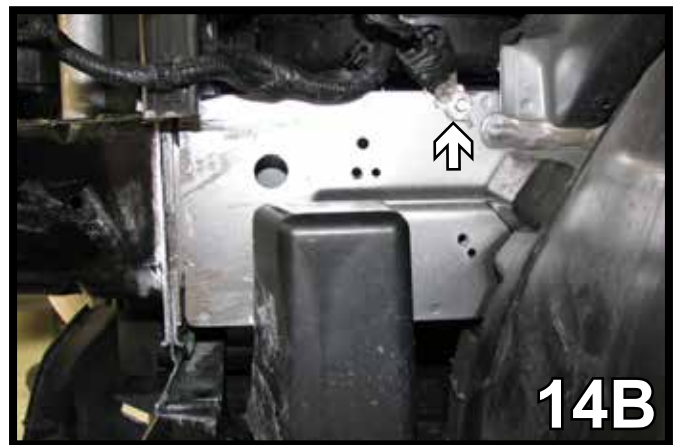
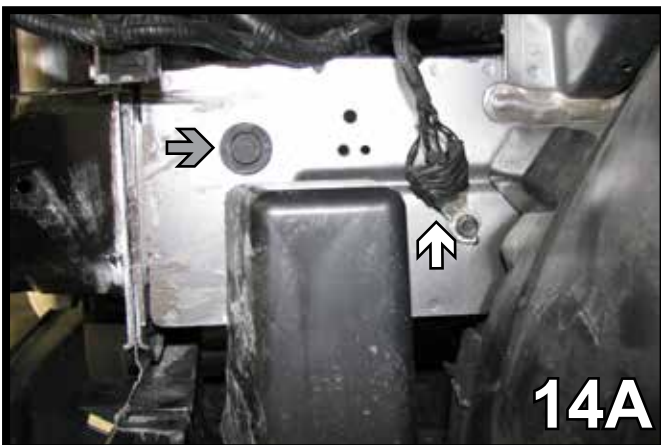

14. Remove the rubber hole cover (gray). Do this on both sides. On the driver's side only, relocate the ground wires (white). Remove from their present location (14A). Use #10-16 x 1" self tapping screw which is included to relocate (14B).

BX2329
2010-15 Hyundai Tucson
Installation Instructions



15. Using the 1 1/4" hole saw, starting with the existing hole cut an opening in the top of the bumper bracket to use for wire nut installation. Do this on both sides.

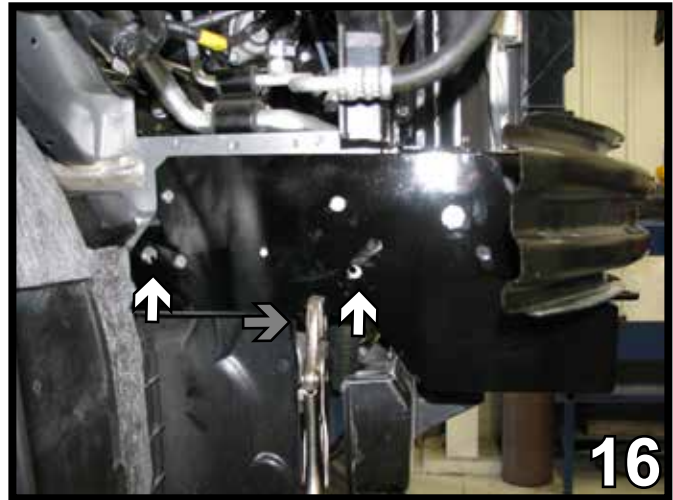

16. Slide baseplate onto the frame to align the existing holes (white arrows) and clamp (gray arrow). **Keep the baseplate level with the frame. Do this on both sides.**



17. Using the baseplate as a template, drill the top front hole with the 13/32" drill bit. Insert the 3/8" nut plate into the 1 1/4" hole to align with drilled hole, tighten the 3/8-16 x 1 1/4" bolt and 3/8" lock washer into nut plate. **Be sure and use loctite red on all bolts before tightening.** The baseplate should be flush with the bottom of the frame rail.

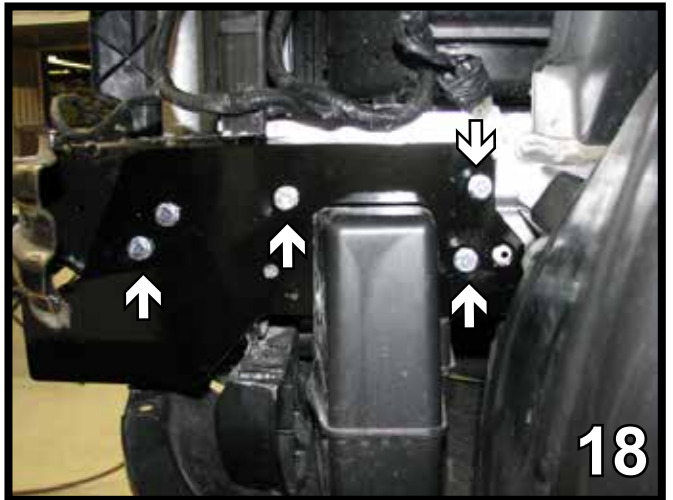

18. Using the baseplate as a template, drill the additional four holes with the 13/32" drill bit. Insert the 3/8" nut plates into the 1 1/4" hole to align with drilled holes, tighten the 3/8-16 hex bolts and lock washers into nut plate. **Be sure and use loctite red on all bolts before tightening. Tighten all bolts according to the torque chart in the General Instruction sheet. Cover the 1 1/4" holes with tape and paint on both sides.**

BX2329
2010-15 Hyundai Tucson
Installation Instructions



19. Reinstall washer reservoir on the passenger's side using the existing bolts and a 6MM-1 x 30MM hex bolt, 5/16" lock washer, 5/16" flat washer as shown in the drawing on page 2. **Be sure all electrical components and hoses are plugged in properly.**

20. Attach the permanent baseplate safety cables to the provided convenience link on the baseplate. Additional options may interfere with suggested mounting; in this case, secure the cables to a solid piece of the frame as described in the instructions included with the permanent baseplate safety cables. Be sure the safety cables do not rub against any hoses or moving parts. Do this on **BOTH** sides of the vehicle.



21. While holding the fascia as close to its original position as possible, mark the area around the removable tabs. Cut the grille around the outside edge of the removable tab receivers. Do this on both sides. Reinstall fascia.

BX2329
2010-15 Hyundai Tucson
Installation Instructions



CUSTOMER SERVICE COMMITMENT

Blue Ox® is committed to providing you with exceptional customer care throughout your lifetime with our products. Our team is here to assist you with any questions you may have regarding the performance of your product. Simply call (402) 385-3051 and you can speak with our customer care team.

Additionally, please visit our website to see which rallies our Destination America team will be attending. For a nominal fee, our service technician will service your towing system to ensure it's in proper working condition. Also, as a commitment to our customers, should you visit our factory, you can stay at our full service Blue Ox® campground at no charge along with enjoying a factory tour.

Again, thank you for being our customer and for the confidence you have shown in the performance of our products. It is because of customers like you we enjoy the success we have today.

© 2015 Blue Ox
One Mill Road, Industrial Park
Pender, Nebraska 68047
Phone: (402) 385-3051
Fax: (402) 385-3360
www.blueox.com

General Information

1. Ensure that your product(s) are registered online at www.blueox.com. It is crucial to register your product(s) so that you may be alerted of product offerings, updates, upgrades, maintenance and safety bulletins, and/or recalls.
2. **It is the owner's responsibility to inspect all towing equipment for cracked welds, missing or worn parts and loose bolts before each towing trip.** Be sure to use Loctite® Red on all bolts and tighten to the recommended specifications.
3. **It is the owner's responsibility to hook up all towing equipment per manufacturer's instructions/recommendations.**
4. Remove the attachment tabs when not in use (if applicable).

Notice To Baseplate Installer

1. It is YOUR responsibility to watch for:

- Oil cooler and air conditioner lines
- Electrical wires and hoses
- Missing parts or attaching points on the frame

** If the baseplate is improperly installed and is against a wire or hose, it could cause fluid leaks or electrical shorts some time after the actual baseplate installation.

Permanent Baseplate Safety Cable Installation

Permanent baseplate safety cables are strongly recommended when towing a vehicle with a tow bar. The principle function of the permanent baseplate safety cables is to prevent the towed vehicle from breaking loose in the event the connection between the frame of the towed vehicle and the baseplate fails or becomes disconnected. The cables must be connected from the baseplate to the frame rail or cross member of the vehicle's frame. The illustrations below show the possible arrangements recommended by Blue Ox®. Each permanent baseplate safety cable must have an adequate weight rating for the towing system. The weight rating of the two (2) cables together will not qualify.

Do not mount the permanent baseplate safety cables against wires, hoses or brake lines.

These permanent baseplate safety cables should remain installed as long as the baseplate is installed on the vehicle. Permanent baseplate safety cables are to be used in conjunction with, and NOT a replacement for legally required safety cables attaching the towed vehicle to the towing vehicle.

OPTION #1

Permanent Baseplate Safety Cables to Cross Member or Frame of Towed Vehicle.



OPTION #2

Permanent Baseplate Safety Cables to Cross Member or Frame of Towed Vehicle.

