

Please read BOTH these Installation Instructions and the General Instructions before attempting to install or operate this equipment.

- Blue Ox® towing products and accessories are intended to be installed by Blue Ox® Dealers who are familiar with our products and have the equipment necessary and knowledge to do "fit work". When necessary Blue Ox® Dealers can be found at www.blueox.com or by contacting our Customer Care Department at (402) 385-3051.
- Many Blue Ox® Baseplates are designed to use existing holes and hardware to mount the baseplate to the towed vehicle. Even though bolts are there, do not assume they are adequate for baseplate mounting. Always use hardware supplied in the hardware kit and existing hardware specified in the Baseplate Installation Instructions.

Attachment Tab Height: 14"

Attachment Tab Width: 24"

Bolt Torque Specifications

Torque in Foot-Pounds for Metric Bolts

Bolt Size	Grade 8.8	Grade 10.9
6MM	6	8
8MM	16	22
10MM	31	40
12MM	54	70
14MM	89	117

Confirm the towability and pre-towing procedures for your vehicle with the owner's manual or contact the vehicle's manufacturer for specific towing procedures.



If the front of your vehicle looks different than this, call us at (402) 385-3051.

Bolt Torque Specifications

Torque in Foot-Pounds for Inch Bolts

Bolt Size	Grade 5	Grade 8
1/4"	10	14
5/16"	19	29
3/8"	33	47
7/16"	54	78
1/2"	78	119
5/8"	154	230

WARNING

Failure to read and follow these instructions could result in separation of the towed vehicle from the tow bar, causing property damage, loss of towed vehicle, personal injury or death.

BX2249

2008-10 Honda Accord

Installation Instructions

Parts List

Ref. No.	Qty.	Part #	Description
1	1	61-6594	WLDM'T, BP, BX2249
2	4	61-5208	WLD, NUT PLT, 1/4X1X1, 3/8"/14"WIRE
3	4	61-4978	3/8 INCH WHIZ NUT WITH 14 INCH WIRE
4	8	201-0368	3/8-16 X 1 1/4 HEX HEAD BOLT,GRD. 5
5	8	203-0010	3/8 LOCK WASHER, ZP
6	1	107-3081	TUBE, 1/2 OD. X 18GA. W X .63"
7	1	203-0001	1/4 FLAT WASHER, ZP
8	1	201-0709	6MM-1MM X 80MM H.BOLT, GRD 8.8, ZP
9	2	201-0553	1/4-20 X 1/2 HX.WSHD.TYPE F TCS, ZP
10	2	201-0192	10-32 X 1/2 SLOT, RD. HD. SCREW
11	2	203-0054	#10 LOCK WASHER
12	2	202-0047	#10-32 HEX NUT
13	2	101-5822	ADAPTER, 4 WAY CONNECTOR
14	2	62-3469	ATT TAB ASSY, REM, SF/LB, 1 HOLE
	2	226-0046	BASEPLATE SAFETY CABLE, 36" CL III (NS)
	2	229-0359	QUICKLINK, 3/8, ZP (Not Shown)
	2	290-0437	RECEIVER, CAP PLUG (BLK) (Not Shown)

Tools Required

10MM Socket	Drill
10MM Wrench	Flat Screw Driver
12MM Socket	Phillips Screw Driver
9/16" Socket	Tape Measure
5/8" Wrench	Small Flat Screw Driver
Large Vise Grip	3/8" Drill Bit
Reciprocating Saw	Loctite® RED

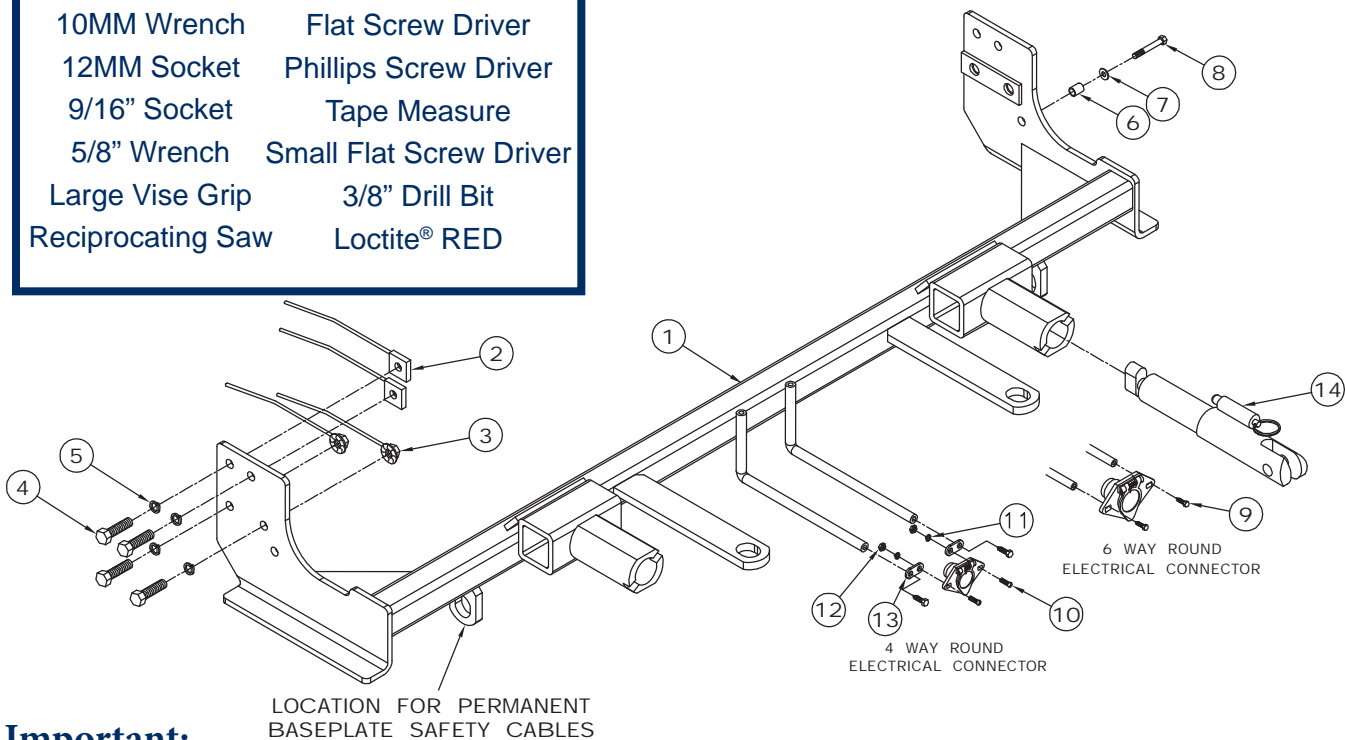

Important:

Use only genuine factory replacement parts on your baseplate. Do **NOT** substitute homemade or non-typical parts. If a bolt is lost or in need of replacement, for your safety and the preservation of your baseplate, be sure to use a replacement bolt of the same grade (In most cases it will be Grade 5, please reference the parts list above). Replacement parts may be ordered through your nearest Blue Ox® Dealer or Distributor, or call our Customer Care Team at (402)385-3051. Failing to follow and/or altering these installation instructions in either installation or required equipment will void the manufacturer's warranty. Towing behind a non-motorized vehicle will void the warranty.

BX2249 2008-10 Honda Accord

Installation Instructions

Attachment Tabs:

Due to the design of the removable tabs, the RangeFinder II tow bar can not be used. Adapters, except the BX8833 and BX88151, can not be used with this baseplate.

Installation Notes:

The radiator cover, fascia, bumper and extension are removed for the baseplate installation. Drilling is required. Headlights are removed and replaced for installation.

Some vehicles fascia's may need trimming. The dimensional variations between otherwise identical vehicles can be considerable. While the baseplate was designed for easy installation, it may be necessary to tailor the baseplate slightly to compensate for auto manufactures' tolerances. These minor adjustments may include filing a hole slightly, bending electrical rods or bending end plates.

The Bx8848 4-Diode Wiring Kit is recommended for this vehicle.

Handling of some cosmetic parts when installing this product may require the use of protective covers, rags, specialty tools, etc. to prevent damage.

Installation Instructions:



1. Remove eight push pins in order to remove the radiator cover. Do this to both sides of the vehicle. Set cover and push pins aside to be reinstalled later.



2. In the corner of the fascia, remove the Phillips screw. Do this to both sides of the vehicle. Set screw aside to be reinstalled later.

BX2249

2008-10 Honda Accord

Installation Instructions



3. Underneath the fascia, remove ten push pins all the way around. Set push pins aside to be reinstalled later.



4. Pull the fascia out up to the blinker. Use a small flat screw driver to pry down on each clip in the series of four in order to release the fascia. Pull the two eyelets up off the pins. Do this on both sides. Slide the fascia off, disconnect fog lights and set aside carefully to be reinstalled later.

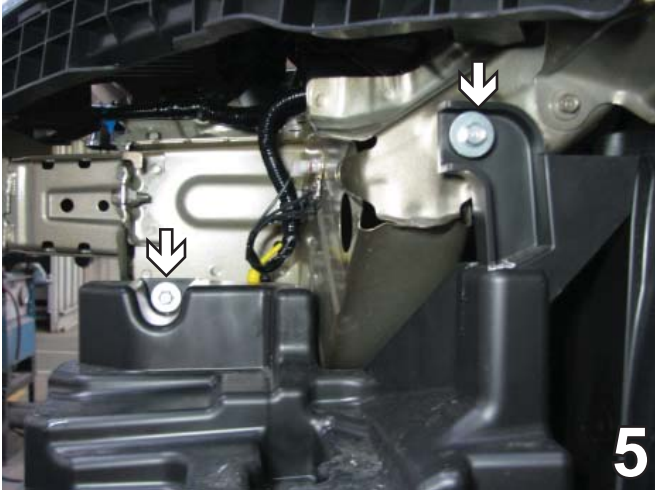

6. On the driver's side, use a 10MM socket to remove the two bolts holding the air baffle. Don't remove the air baffle just pull it back out of the way. Set the bolts aside to be reinstalled later.



6. On the driver's side, remove the push pin just forward of the front tire in the wheel well. Set the push pin aside to be reinstalled later.

BX22429

2008-10 Honda Accord

Installation Instructions

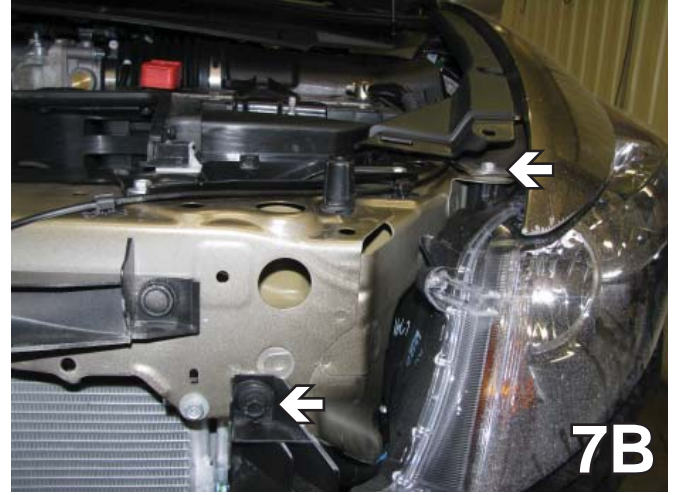

7. Remove the headlight by removing the three bolts around it and unplug the electrical connections. Do this on both sides. Set the bolts and headlights aside to be reinstalled later.



8. Behind the bumper, disconnect the temperature sensor by pulling the cable out before taking the bumper off.
9. Using a 12MM socket remove the four metric bolts holding the metal bumper and extension. This is done to both sides. Pull the metal bumper forward and set carefully aside to be reinstalled later.

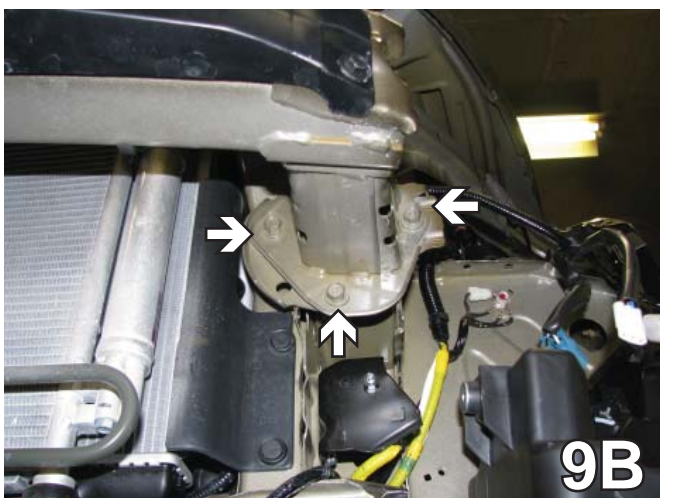

BX2249

2008-10 Honda Accord

Installation Instructions

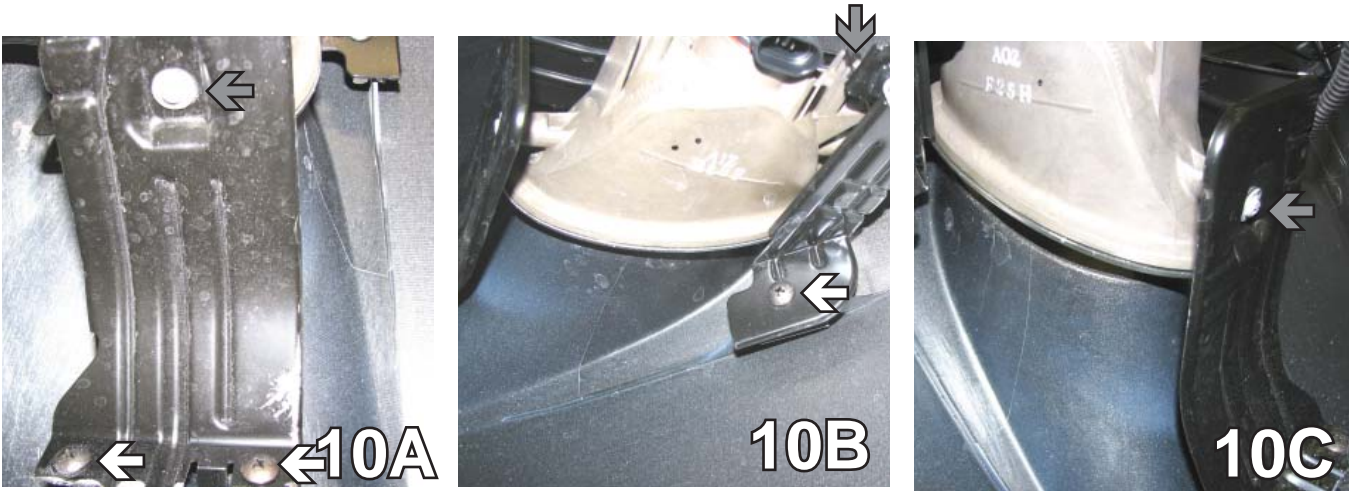

10. Using the Phillips screw driver, remove the three Phillips screws to take the fog light bracket off the back of the fascia (white arrows). Continue to remove three additional screws to take the bulb housing off. Do this on both sides. Set the screws aside to be reinstalled shortly.

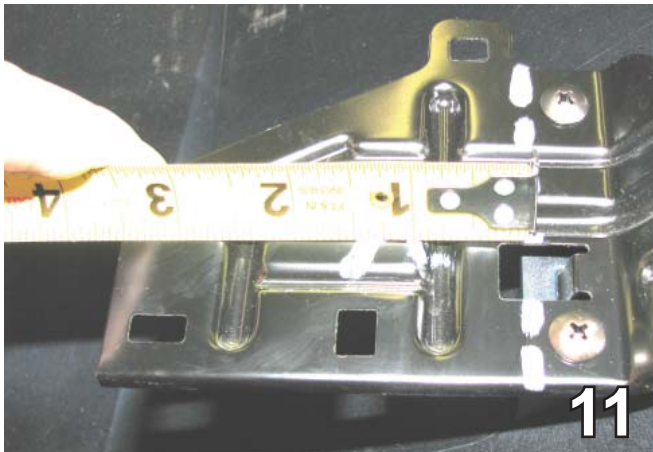

11. Cut the fog light bracket on the white line. Replace the housing to the bracket and reattach back to the fascia. Do this on both sides.



12. With the vehicle on a level surface, slide the baseplate up and in. The top of the baseplate should be flush with the frame offset and 7/8" down from the frame ledge. Be sure the baseplate is level with respect to the vehicle frame. Clamp with the large vise grip. Drill one hole (white arrow) with a 3/8" drill bit, using the baseplate as a template. Be sure the washer reservoir hole (gray arrow) lines up. Insert 3/8-16 x 1 1/4" bolt and 3/8" lock washer with 3/8-16 nut plate attached inside the frame. Be sure to use Loctite Red on all the bolts. Drill the remaining three holes. Do this on both sides.

BE SURE TO USE LOCTITE® RED ON ALL BOLTS BEFORE TIGHTENING. TIGHTEN ALL BOLTS ACCORDING TO THE TORQUE CHART ON THE FRONT PAGE OF THESE INSTRUCTIONS OR ON PAGE 3 OF THE BASEPLATE TOWING GENERAL INSTRUCTIONS.

BX2249

2008-10 Honda Accord

Installation Instructions

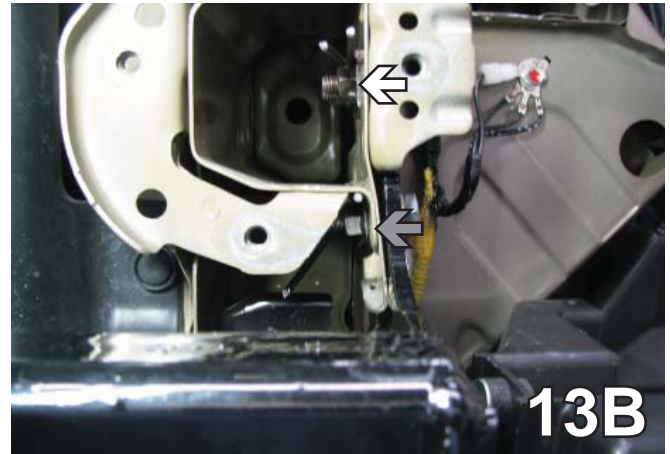
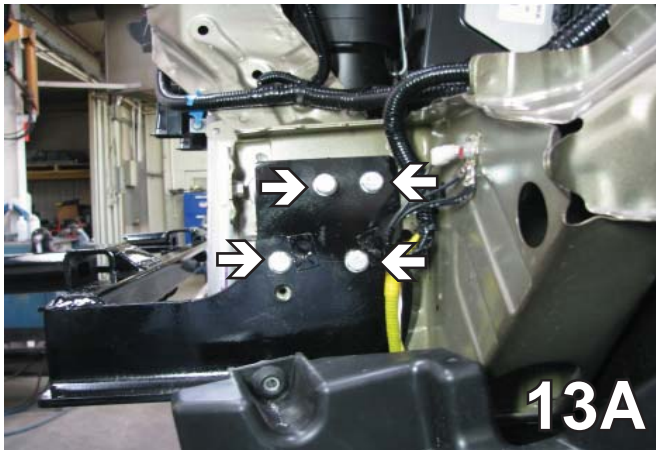

10. Use 3/8-16 x 1 1/4" bolts and 3/8" lock washers in all the holes. The top two attach to 3/8-16 nut plates (13B white arrow) inserted inside the frame. The bottom two attach to 3/8-16 whiz nuts. Be sure to use Loctite Red on all the bolts. Do this on both sides.



14. Attach the permanent baseplate safety cables to the provided convenience link on the baseplate (see grey arrow). The photo above shows the recommended installation of the cables to frame of vehicle (see white arrow). Additional options may interfere with suggested mounting; in this case secure the cables to a solid piece of the frame as described in the instructions included with the permanent baseplate safety cables. Be sure the safety cables do not rub against any hoses or moving parts. Do this to both sides of the vehicle.

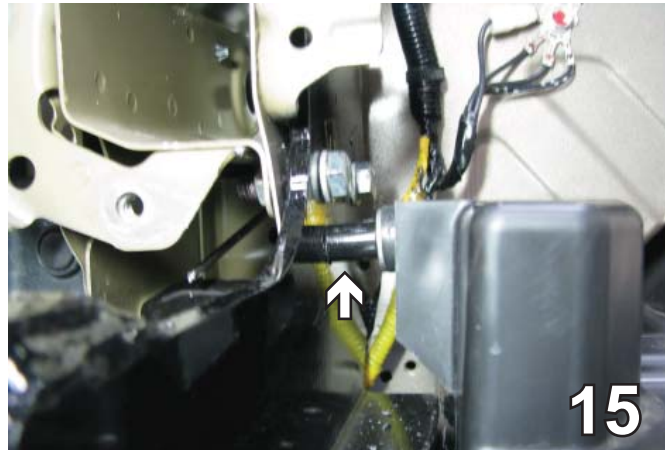

15. Reattach the air baffle with a 6MM-1.0MM x 80MM bolt, 1/4" flat washer and a 1/2 OD. x 18 GA.W x .63" tube.
16. Reinstall the bumper and reconnect the temperature sensor, the headlights, the fascia, the fog lights and the radiator cover.
17. Install the tow bar and safety cables according to the instructions when demonstrating this to the customer. Be sure to include all the contents and packages.
18. Do **NOT** substitute other devices if the tow bar pins and clips are misplaced.

BX2249

2008-10 Honda Accord

Installation Instructions

Be sure that ALL electrical connections are plugged in properly and functioning BEFORE Installing the fascia.

DEALER or INSTALLER:

Be certain the user receives the instructions sheets for their products.

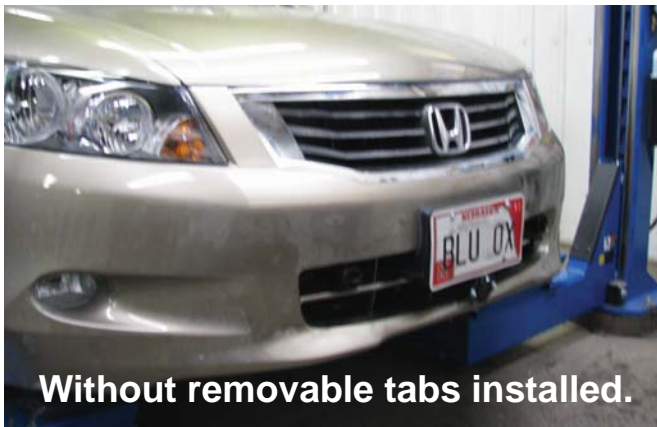

Without removable tabs installed.



With removable tabs installed.

If the baseplate is in an accident, it must be replaced. DO NOT use it again! An accident can cause unseen damage and using it again could result in more damage or serious injury. DO NOT use the baseplate if it is damaged or missing parts.

CUSTOMER SERVICE COMMITMENT

Blue Ox is committed to providing you with exceptional customer care throughout your lifetime with our products. Our team is here to assist you with any questions you may have regarding the performance of your product. Simply call (402) 385-3051 and you can speak with our customer care team.

Additionally, please visit our website to see which rallies our Destination America team will be attending. For a nominal fee, our service technician will service your towing system to ensure it's in proper working condition. Also as a commitment to our customers, should you visit our factory you can stay at our full service Blue Ox campground at no charge along with enjoying a factory tour.

Again thank you for being our customer and for the confidence you have shown in the performance of our products. It is because of customers like you we enjoy the success we have today.



© 2008, 10 Blue Ox
One Mill Road, Industrial Park
Pender, Nebraska 68047
Phone: (402) 385-3051
Fax: (402) 385-3360
www.blueox.com