



BX1982 2008 Chrysler 300C

Installation Instructions

Serial Number

Please read BOTH these Installation Instructions and the General Instructions before attempting to install or operate this equipment.

- Blue Ox® towing products and accessories are intended to be installed by Blue Ox® Dealers who are familiar with our products and have the equipment necessary and knowledge to do “fit work”. When necessary Blue Ox® Dealers can be found at www.blueox.com or by contacting our 24/7 Customer Care Department at (402) 385-3051 or toll free (888) 425-5382.
- Many Blue Ox® Baseplates are designed to use existing holes and hardware to mount the baseplate to the towed vehicle. Even though bolts are there, do not assume they are adequate for baseplate mounting. Always use hardware supplied in the hardware kit and existing hardware specified in the Baseplate Installation Instructions.

Attachment Tab Height: 12.5”

Attachment Tab Width: 34”

Bolt Torque Specifications

Torque in Foot-Pounds per Metric Bolts

Bolt Size	Grade 8.8	Grade 10.9
6MM	6	8
8MM	16	22
10MM	31	40
12MM	54	70
14MM	89	117

Confirm the towability and pre-towing procedures for your vehicle with the owner’s manual or contact the vehicle’s manufacturer for specific towing procedures. You can also contact REMCO for additional information at 1(800)228-2481.

Bolt Torque Specifications

Torque in Foot-Pounds per Inch Bolts

Bolt Size	Grade 5	Grade 8
1/4”	10	14
5/16”	19	29
3/8”	33	47
7/16”	54	78
1/2”	78	119
5/8”	154	230



! WARNING

Failure to read and follow these instructions could result in separation of the towed vehicle from the tow bar, causing property damage, loss of towed vehicle, personal injury or death.

BX1982 2007 Chrysler 300C Installation Instructions

Parts List

Ref. No.	Qty.	Part #	Description
1	1	61-6506	WLDM'T, BASEPLATE, BX1982
2	4	61-5208	WLDT, NUT PLT, 1/4X1X1, 3/8 BLT WIR
3	4	107-3038	SPACER, 3/4 OD(.172W) X 5/8 INCH
4	4	201-0440	3/8-16 X 1 1/2 HEX BOLT, GRD.5, ZP
5	4	201-0404	3/8-16 X 1 3/4 HX FUL TD BLT,GD5 ZP
6	8	203-0010	3/8 LOCK WASHER, ZP
7	4	202-0003	3/8-16 HEX NUT, ZP
8	2	201-0979	#12-14 x 1" Self Drilling Screw, ZP
9	2	201-0192	10-32 X 1/2 SLOT, RD. HD. SCREW
10	2	203-0054	#10 LOCK WASHER
11	2	202-0047	#10-32 HEX NUT
12	2	101-5822	ADAPTER, 4 WAY CONNECTOR
13	2	62-3469	ATT TAB ASSY, REM, SF/LB, 1 HOLE
	2	226-0046	BASEPLATE SAFETY CABLE, 36" CL III (NS)
	2	229-0359	QUICKLINK, 3/8, ZP (Not Shown)
	2	290-0437	RECEIVER, CAP PLUG (BLK) (Not Shown)

Tools Required

- 7MM Socket
- 10MM Socket
- 13MM Socket
- 9/16" Socket
- 13/32" Drill Bit
- Diagonal Cutters
- Large Vise Grips
- Utility Knife
- 1 1/4" Hole Saw
- LOCTITE Red

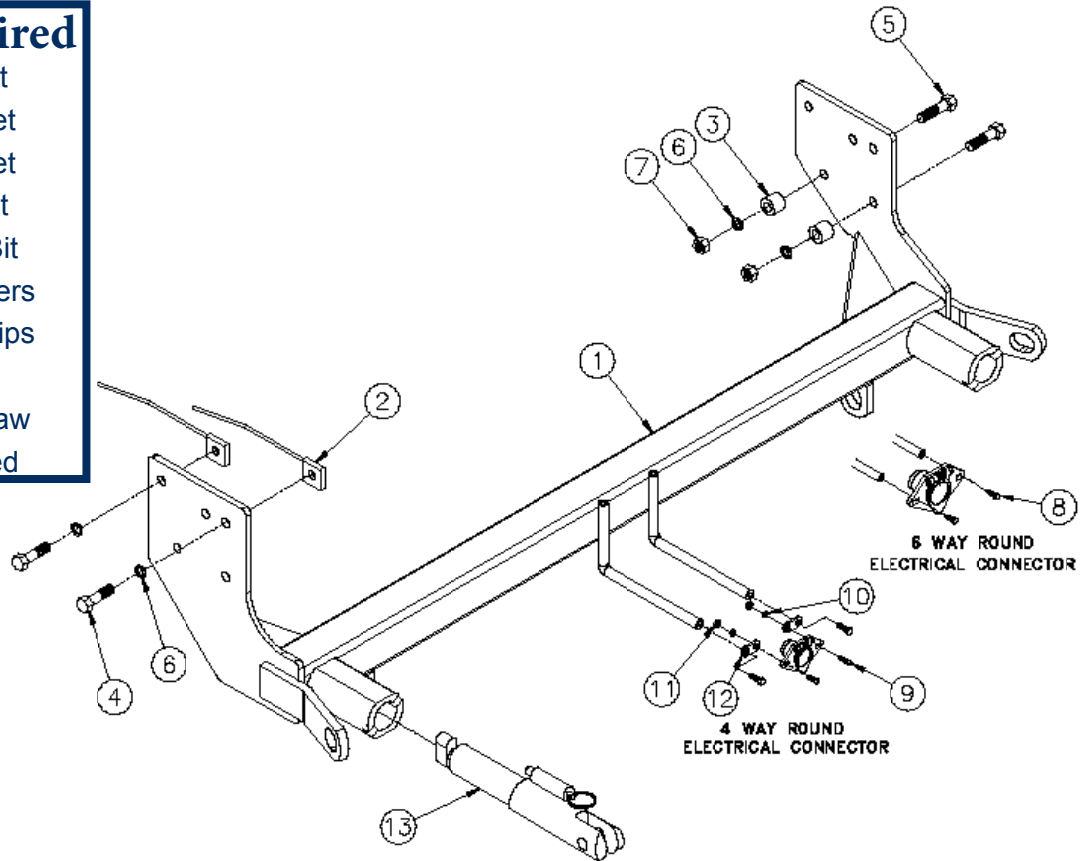

Important:

Use only genuine factory replacement parts on your baseplate. Do NOT substitute homemade or non-typical parts. If a bolt is lost or in need of replacement, for your safety and the preservation of your baseplate, be sure to use a replacement bolt of the same grade (In most cases it will be Grade 5, please reference the parts list above). Replacement parts may be ordered through your nearest Blue Ox® Dealer or Distributor, or call our 24/7 Customer Care Team at (402)385-3051.

BX1982

2007 Chrysler 300C

Installation Instructions

Removable Tab:

Due to the design of the removable tabs, the RangeFinder II and Ambassador tow bars can not be used. Adapters, except the BX8833 and the BX88151, can not be used with this baseplate.

Instructions:

The fascia, bumper, air baffle and washer reservoir, bolts and push pins are removed and reinstalled for the baseplate installation. Drilling is required. Trimming is required.

The dimensional variations between otherwise identical vehicles can be considerable. While the baseplate was designed for easy installation, it may be necessary to tailor the baseplate slightly to compensate for auto manufacturer's tolerances. These minor adjustments may include filing a hole slightly, bending electrical rods, and/ or bending end plates.

The BX8869, Bulb & Socket Wiring Kit is recommended for this vehicle.

Installation Instructions



1. Remove the four push pins on the top side of the fascia. Set aside to be reinstalled later.



2. Remove the nine metric bolts from the lower edge of fascia all the way around with the 7MM socket. Set aside to be reinstalled later.

BX1982
2007 Chrysler 300C
Installation Instructions



3. Just forward of the front tires in the wheel well, cut the three plastic push poppers with the diagonal cutters. Do this on both sides.



4. Pull the plastic back from the wheel well. Remove two metric bolts with the 10MM socket. Do this on both sides and set aside to be reinstalled later. Pull fascia corners out to the side of the vehicle, then pull fascia forward, unplug electrical connection on passenger's side and carefully set the fascia aside to be reinstalled later.

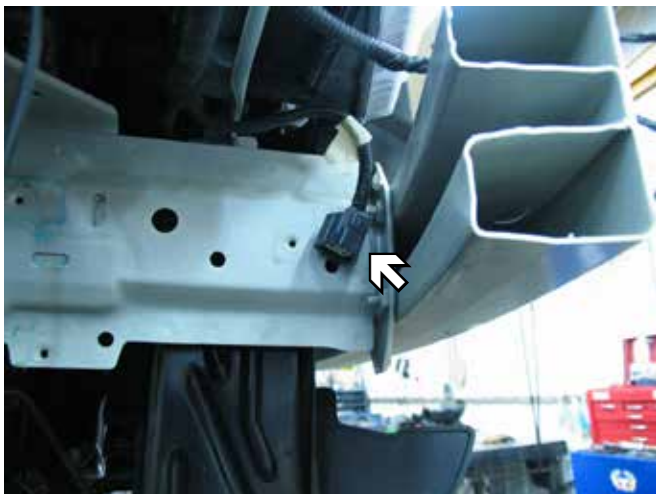

5. On the passenger behind the bumper, disconnect fascia cable from the frame. To prepare area for baseplate install.



6. On the passenger side, use a 10MM socket to remove the bolt holding the air baffle. Set both the air baffle and the bolt aside to be reinstalled later.

BX1982

2007 Chrysler 300C

Installation Instructions

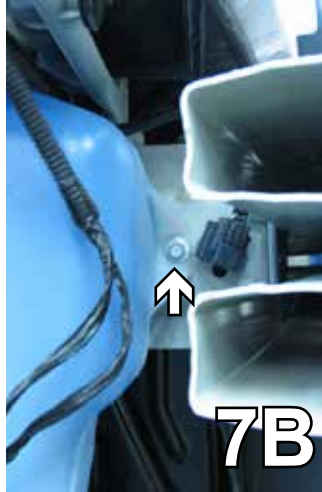
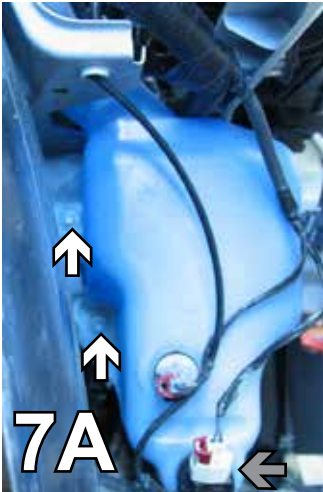

7. On the passenger side, using a 10MM socket, remove the three bolts holding the washer reservoir. Unplug the wires (gray arrow) and plug the water line. Set aside to be reinstalled later.

8. With the fascia upside down, push the clip down with the flat screwdriver to remove the black flat pieces. Do this on both sides of the fascia.

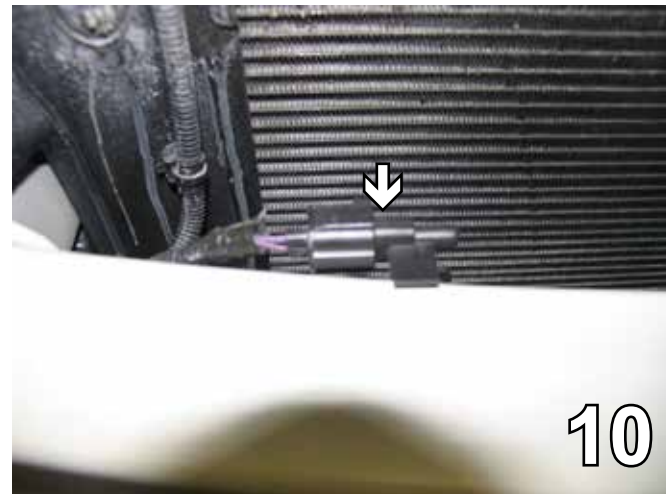
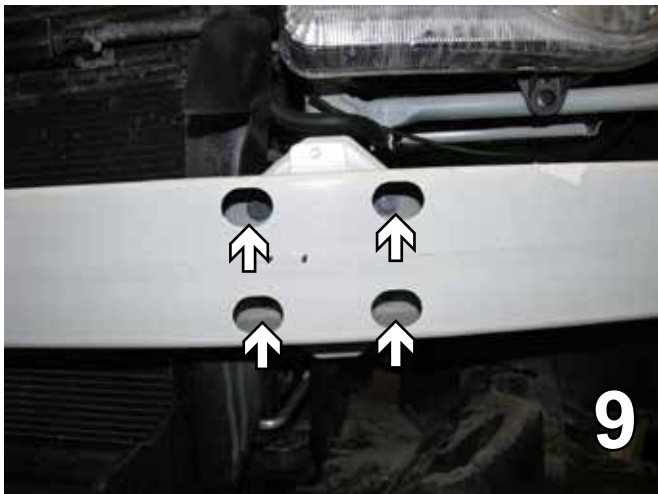

9. To remove the bumper, using a 13MM socket, remove the four bolts. Do this to both sides. Pull the bumper forward. Set aside the bumper and the bolts for later reinstallation.

10. On the back side of the bumper, unplug the air temperature control. Remember to replug after the bumper is reinstalled.

BX1982
2007 Chrysler 300C
Installation Instructions

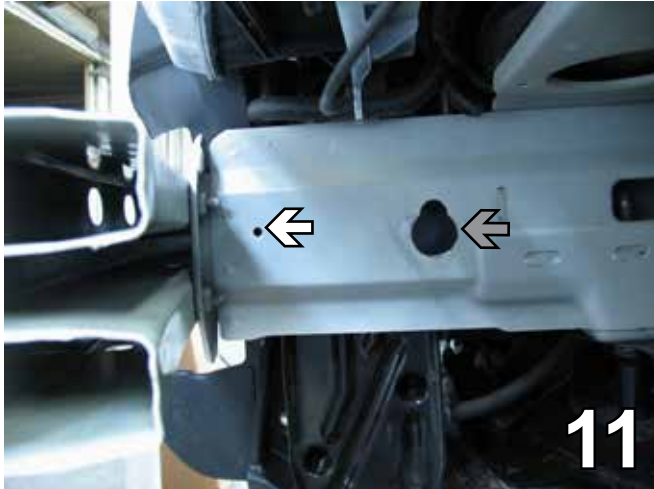

11. On the driver's side, with a 1 1/4" hole saw, drill a hole with the back existing hole to insert the wire nut for baseplate installation. Use the 13/32" drill bit to enlarge the existing hole (white arrow) as a starting point.

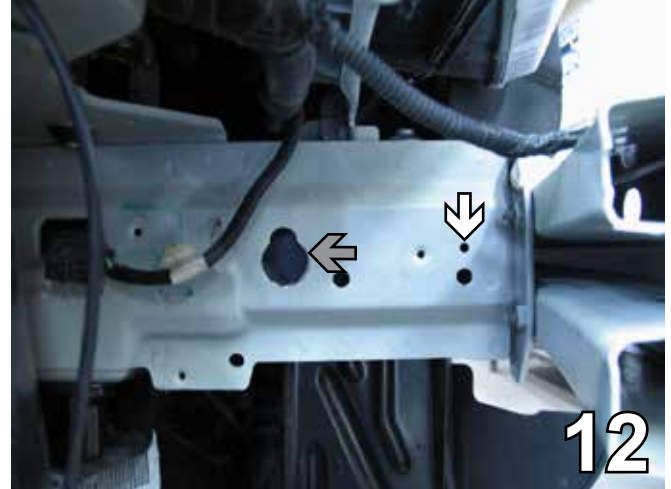

12. On the passenger side, using the 13/32" drill bit, drill another hole in alignment with the washer reservoir existing hole. Also enlarge the existing hole to the back with a 1 1/4" hole saw (gray arrow).

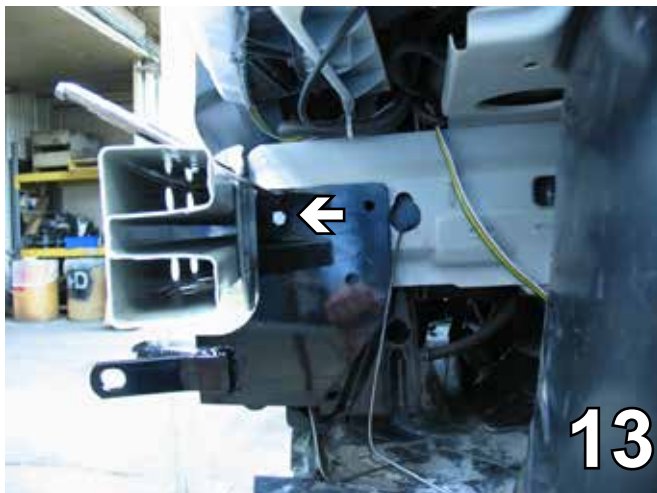

13. Slide the baseplate up from underneath, line up with the drilled hole. Make sure the baseplate is straight and clamp. Using the baseplate as a template, drill the remaining three holes with the 13/32" drill bit.

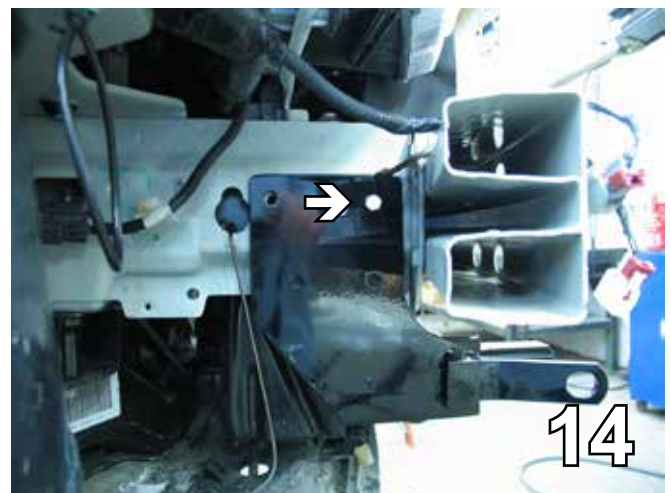

14. On the passenger side, slide the baseplate up from underneath, align with the drilled hole and the existing washer reservoir hole. Make sure the baseplate is straight and clamp. Using the baseplate as a template, drill the remaining two holes with the 13/32" drill bit.

BX1982

2007 Chrysler 300C

Installation Instructions



15. In the top holes on both sides, insert 3/8-16 x 1 1/2" hex bolts with 3/8" lock washers and 61-5208 nut plates inserted inside the frame. In the bottom holes (gray arrows) on both sides, insert 3/8-16 x 1 3/4" hex bolts attach to spacers with 3/8" lock washers and 3/8" hex nuts. Tighten with loctite Red. Do this to both sides of the vehicle.

18. Reinstall the washer reservoir, air baffle, bumper, fascia, bolts and push pins. Reconnect the air temperature control sensor.

16. On the passenger side, reattach the air baffle and the washer reservoir. Reconnect wires and hoses.

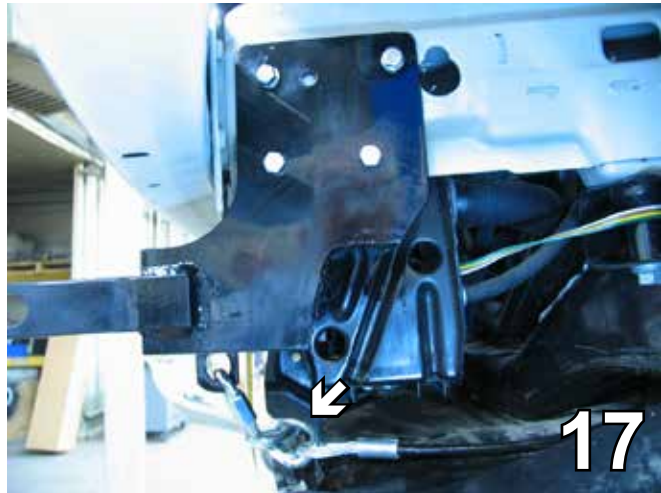

17. Attach the baseplate safety cables. Position the cables around a solid piece of the frame.

BE SURE TO USE LOCTITE® RED ON ALL BOLTS BEFORE TIGHTENING. TIGHTEN ALL BOLTS ACCORDING TO THE TORQUE CHART ON THE FRONT PAGE OF THESE INSTRUCTIONS OR ON PAGE 3 OF THE BASEPLATE TOWING GENERAL INSTRUCTIONS.

BX1982

2007 Chrysler 300C

Installation Instructions

Install the tow bar and safety cables according to the instructions included in their packages.

Do not substitute other devices if the tow bar pin and clip are lost.

DEALER OR INSTALLER: BE CERTAIN THE USER RECEIVES THE INSTRUCTION SHEETS.



Customer Service Commitment

Blue Ox® is focused on providing exemplary customer service, as observed in our mission statement and guiding principles. In accordance with this objective, Blue Ox® is proud to provide services such as repairs and general maintenance of Blue Ox® products at over 150 RV Rallies. Look for our Destination America or Blue Ox® Racing service crews at the next rally or race that you attend. If you were not present, you will find an informative, personalized note explaining any services that may have been performed to your Blue Ox® products.

Blue Ox® also offers educational seminars at rallies and through our Parks and Resort teams. In addition, Blue Ox® customers visiting our factory may take advantage of the well-equipped Blue Ox® RV park at no charge to you, our valued and appreciated customer.



© 2007 Blue Ox
One Mill Road, Industrial Park
Pender, Nebraska 68047
Phone: (402) 385-3051
Toll Free: (888) 425-5382
Fax: (402) 385-3360
www.blueox.com