



## BX1689

### 2010-17 Chevy Equinox (All Trims) 2010-17 GMC Terrain/Terrain Denali (All Trims) Installation Instructions

Please read **BOTH** these Installation Instructions and the General Information sheet prior to installing or operating this equipment.

- Blue Ox® towing products and accessories are intended to be installed by Blue Ox® Dealers who are familiar with our products and have the equipment and knowledge necessary to do “fit work”. If needed, Blue Ox® Dealers can be found at [www.blueox.com](http://www.blueox.com) or by contacting our Technical Service Department at (402) 385-3051.
- Many Blue Ox® baseplates are designed to use existing holes and hardware to mount the baseplate to the towed vehicle. Even though bolts are there, do not assume they are adequate for baseplate mounting. Always use the hardware supplied in the hardware kit and existing hardware as specified in the installation instructions.



2016 Equinox



If the front of your vehicle looks different than this, please contact us at (402)385-3051.

#### Serial Number

**Attachment Tab Height: 15-1/2”**

**Attachment Tab Width: 24”**

#### Bolt Torque Specifications

Torque in Foot-Pounds for Inch Bolts

Bolt Size	Grade 5	Grade 8
1/4”	10	14
5/16”	19	29
3/8”	33	47
7/16”	54	78
1/2”	78	119
5/8”	154	230
3/4”	257	380

#### Bolt Torque Specifications

Torque in Foot-Pounds for Metric Bolts

Bolt Size	Grade 8.8	Grade 10.9
6MM	6	8
8MM	16	22
10MM	31	40
12MM	54	70
14MM	89	117
16MM	161	230
18MM	222	318



## WARNING

Failure to read and follow these instructions could result in separation of the towed vehicle from the tow bar, causing property damage, loss of towed vehicle, personal injury or death.

**Reference your vehicle owner’s manual for manufacturer’s towing specifications.**

BX1689  
2010-17 Chevy Equinox (All Trims)  
2010-17 GMC Terrain/Terrain Denali (All Trims)  
Installation Instructions

**Instruction Notes:** The fascia and baffle are removed and reinstalled for the baseplate installation. Some drilling and trimming is required.

Place all components that are removed on a flat, sturdy surface. All items will be reinstalled unless otherwise noted after the baseplate is installed.

The dimensional variations between otherwise identical vehicles can be considerable. While the baseplate was designed for easy installation, it may be necessary to tailor the baseplate slightly to compensate for vehicle manufacturer's tolerances.

The BX8869 Tail Light Wiring Kit is recommended for this vehicle.

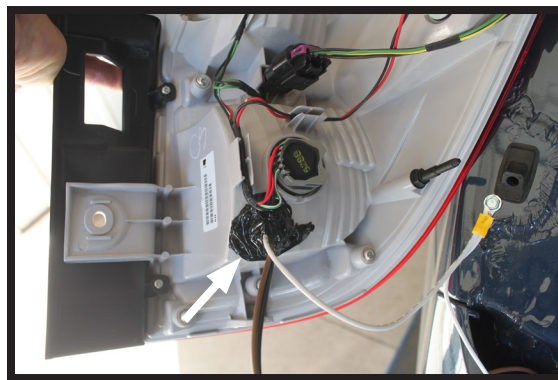

Drill a hole according to the tail  
light wiring kit instructions.

## **NOTICE**

- Handling of some cosmetic parts when installing this product may require the use of protective covers, rags, specialty tools, etc. to prevent damage.
- When using power drills be aware of the dangers of torque and drill bit length.
- When using a reciprocating saw be aware of objects behind the cutting surface.
- Use a good quality paint to spray cut edges of frame to prevent rusting.
- Be sure that **ALL** electrical connections are plugged in and accessories are functioning properly before reinstalling the fascia.
- The baseplate is computer tested to your vehicle's GVWR, exceeding this weight will void the manufacturer's warranty.
- Be sure to use a sufficient amount of Loctite® Red on all bolt threads before tightening. Tighten all bolts according to the torque chart provided.
- Dealer or installer be certain the user receives these instruction sheets.
- If the baseplate is in an accident, it must be replaced. **DO NOT** use it again! An accident can cause unseen damage and using it again could result in more damage or serious injury. **DO NOT** use the baseplate if it is damaged or missing parts.

**BX1689**  
**2010-17 Chevy Equinox (All Trims)**  
**2010-17 GMC Terrain/Terrain Denali (All Trims)**  
**Installation Instructions**

**Tools Required**

Large Vise Grip  
 Utility Knife  
 Phillips Screwdriver  
 Torque Wrench  
 Drill  
 Reciprocating Saw  
 Tape Measure  
 Loctite® RED  
 13/32" Drill Bit  
 7MM Socket  
 10MM Socket  
 7/16" Socket  
 7/16" Wrench  
 9/16" Socket  
 9/16" Wrench  
 T20 Torx

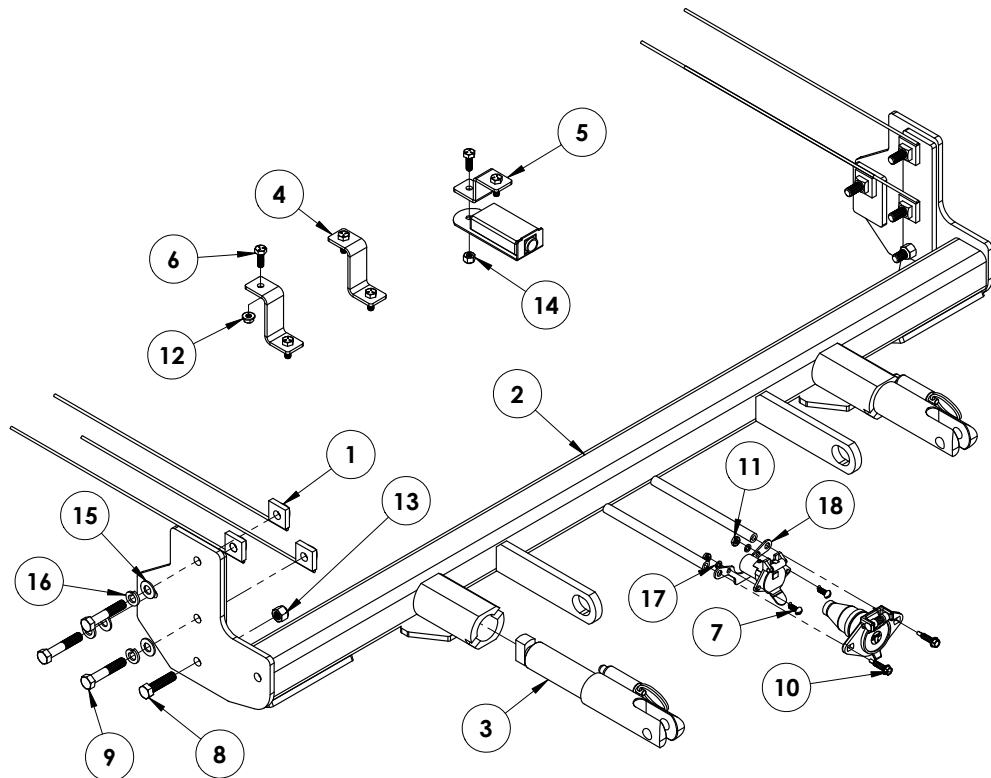

Item No.	Part No.	Description	Qty.
1.....	61-5208.....	3/8"-16 Nut Plate w/ 14" Wire.....	6
2.....	61-6693.....	BX1689 Baseplate.....	1
3.....	62-3469.....	Attachment Tab Assembly with Hole.....	2
4.....	102-7056.....	Cooler Bracket.....	2
5.....	102-7134.....	Breakaway Bracket.....	1
6.....	201-0050.....	1/4"-20 x 3/4" Hex Head Bolt, Grade 5, ZP.....	6
7.....	201-0192.....	#10-32 1/2" Round Slotted Head Screw.....	2
8.....	201-0440.....	3/8"-16 x 1-1/2" Hex Head Bolt, Grade 5, ZP.....	2
9.....	201-0444.....	3/8"-16 x 2" Hex Head Bolt, Grade 5, ZP.....	6
10.....	201-0979.....	#12-14 x 1" Self Drilling Screw, ZP.....	2
11.....	202-0047.....	#10-32 Hex Nut.....	2
12.....	202-0069.....	1/4"-20 Hex Whiz Lock Nut, ZP.....	4
13.....	202-0090.....	3/8"-16 Hex Nylon Insert Lock Nut, ZP.....	2
14.....	202-0102.....	1/4"-20 Hex Nylon Nut, ZP.....	2
15.....	203-0003.....	3/8" Flat Washers, ZP.....	6
16.....	203-0010.....	3/8" Lock Washer, ZP.....	6
17.....	203-0054.....	#10 Lock Washer, ZP.....	2
18.....	299-0685.....	4-Way Bracket.....	1
19.....	226-0046(not shown).....	Class III Safety Cables.....	2
20.....	229-0359(not shown).....	3/8" Quicklink, ZP.....	2
21.....	290-0437(not shown).....	Black Cap Plug Receiver.....	2

**Important:**

Use only genuine factory replacement parts on your baseplate. Do **NOT** substitute homemade or non-typical parts. If a bolt is lost or in need of replacement, for your safety and the preservation of your baseplate, be sure to use a replacement bolt of the same grade (In most cases it will be Grade 5, please reference the parts list above). Replacement parts may be ordered through your nearest Blue Ox® Dealer or Distributor. Failing to follow and/or altering these installation instructions in either installation or required equipment will void the manufacturer's warranty. Towing behind a non-motorized vehicle will void the warranty.

BX1689  
2010-17 Chevy Equinox (All Trims)  
2010-17 GMC Terrain/Terrain Denali (All Trims)  
Installation Instructions

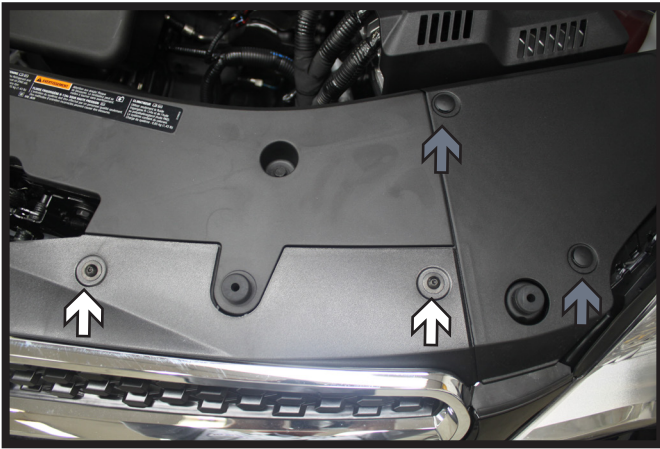

1. Using a T20 Torx, remove the two (2) screws from the top edge of the fascia (white). Then remove the two (2) push pins (gray). Do this on both sides of the vehicle.

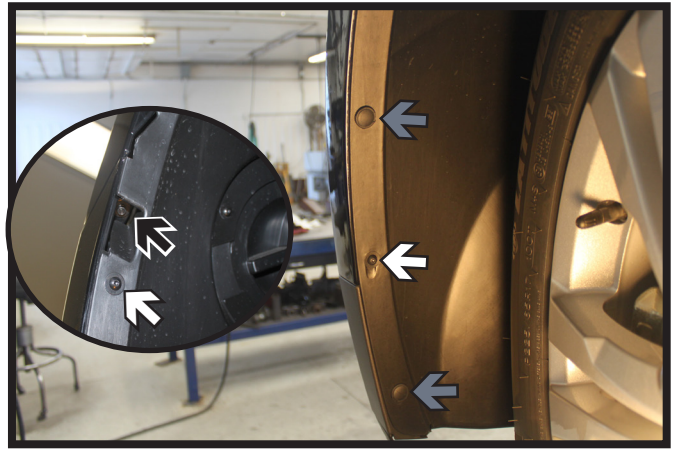

2. **All Models:** Using a T20 Torx, remove the two (2) screws from edge of the wheel well (white). Then remove the two (2) push pins (gray).  
**2014-17 Equinox:** Using a 7MM socket, remove the additional screw along the wheel well (black). Do this on both sides of the vehicle.

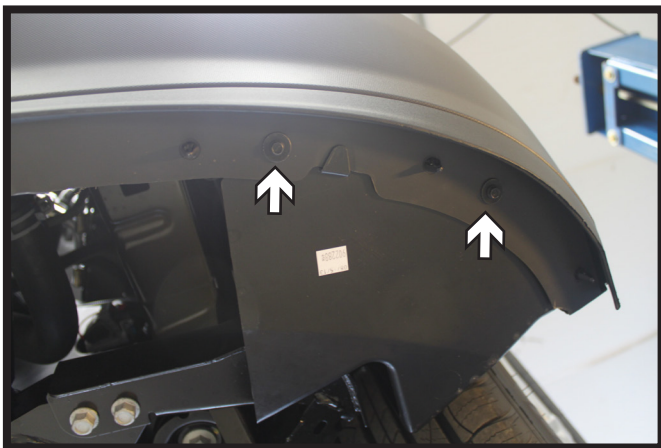

3. Using a 7MM socket, remove the four (4) screws from the underside of the fascia. There are two (2) on each side.



4. Pry the corners of the fascia away from the vehicle. Disconnect all electrical connections and pull the fascia from the vehicle.

BX1689  
2010-17 Chevy Equinox (All Trims)  
2010-17 GMC Terrain/Terrain Denali (All Trims)  
Installation Instructions

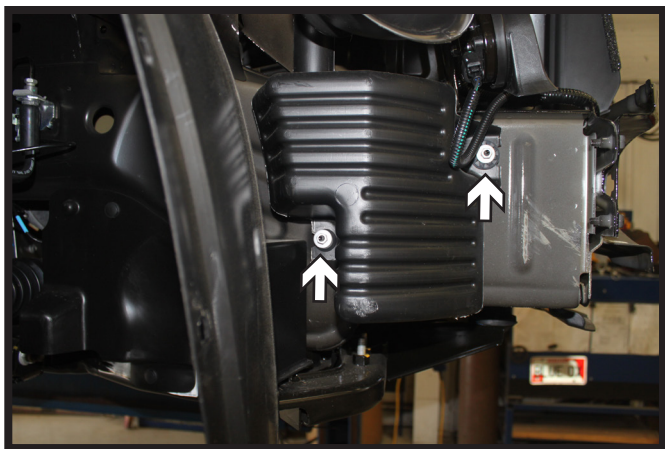

5. Using a 10MM socket, remove the two (2) nuts from the baffle on the passenger side.

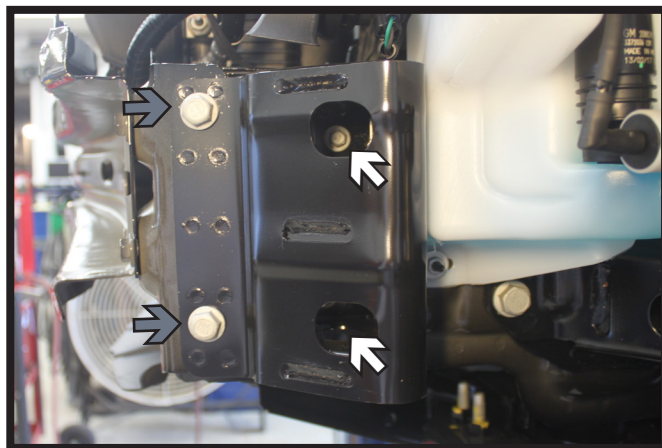

6. **2014-17 Models:** On the driver side, using a 10MM socket, remove the two (2) interior bolts (white) from the reinforcement. Using a 15MM socket, remove the two (2) outer bolts (gray). The reinforcement will not be reinstalled.

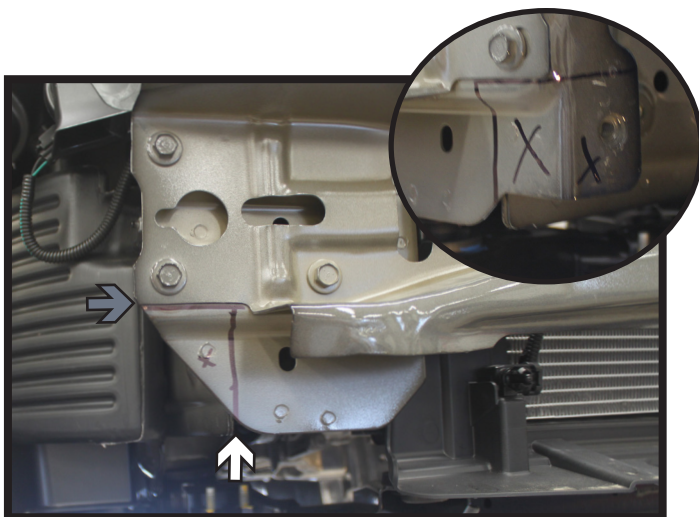

7. Using a reciprocating saw, trim the face of the frame flush with the outside of the frame rail (white) and up to the bumper seam (gray). Do this on both sides of the vehicle.

**2014-17 Models:** On the driver side, the frame face will be squared off, but trimming remains the same (inset).

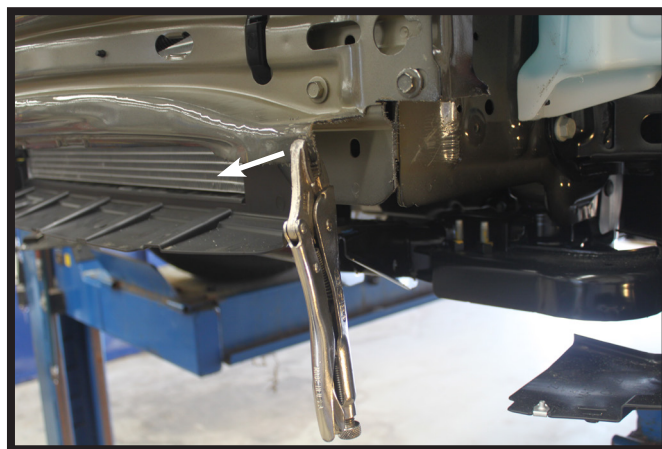

8. Bend the outer flanges of the bumper out approximately 90° to the bottom of the bumper. Do this on both sides of the vehicle.

BX1689  
2010-17 Chevy Equinox (All Trims)  
2010-17 GMC Terrain/Terrain Denali (All Trims)  
Installation Instructions

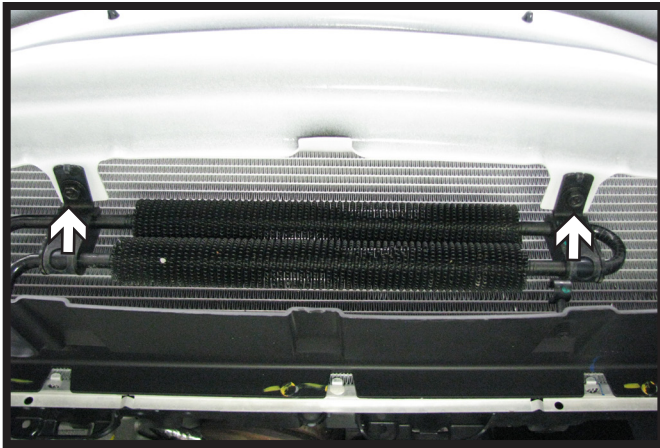

9. If equipped, remove the two (2) bolts from the cooler and move it down to allow the baseplate to be installed.

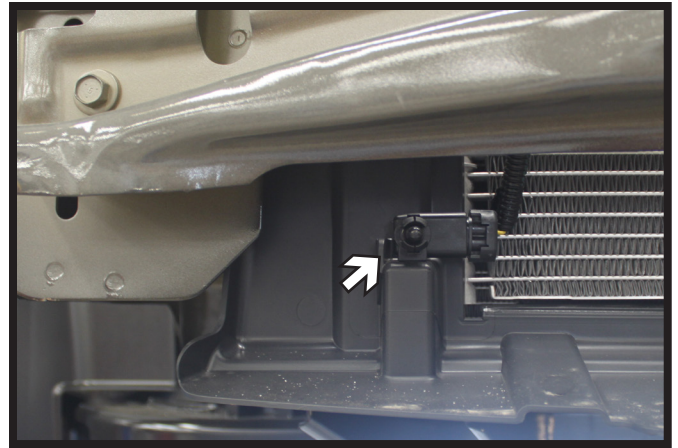

10. Unsnap the temperature sensor and move it aside for baseplate installation.

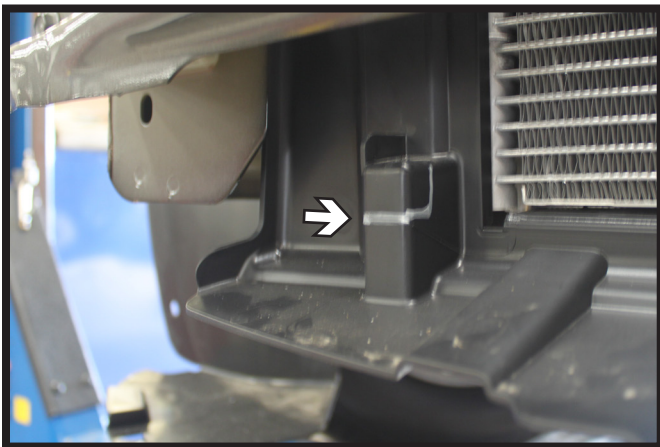

11. Trim the temperature sensor housing as shown. Approximately 5/8" high x 1/2" deep (left).  
**2016-17 Models only:** Trim the outer edge of the lower plastic shielding (right). Do this on both sides of the vehicle.

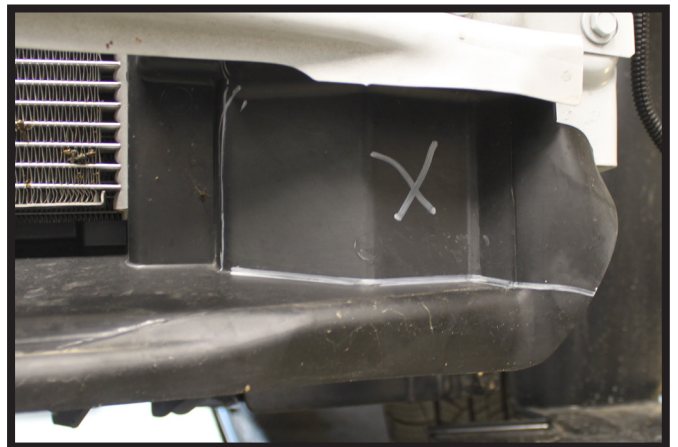

BX1689  
2010-17 Chevy Equinox (All Trims)  
2010-17 GMC Terrain/Terrain Denali (All Trims)  
Installation Instructions

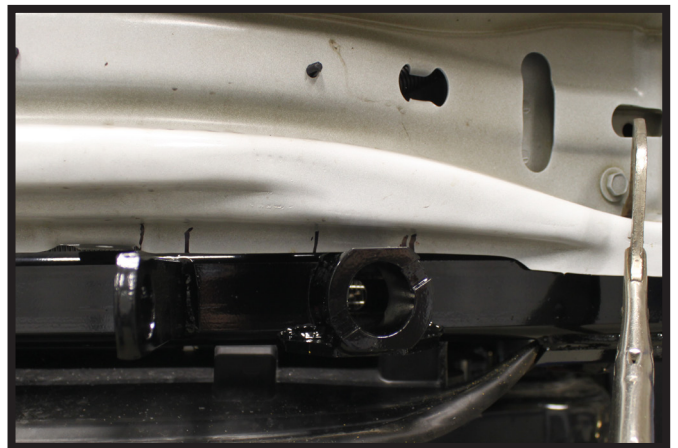
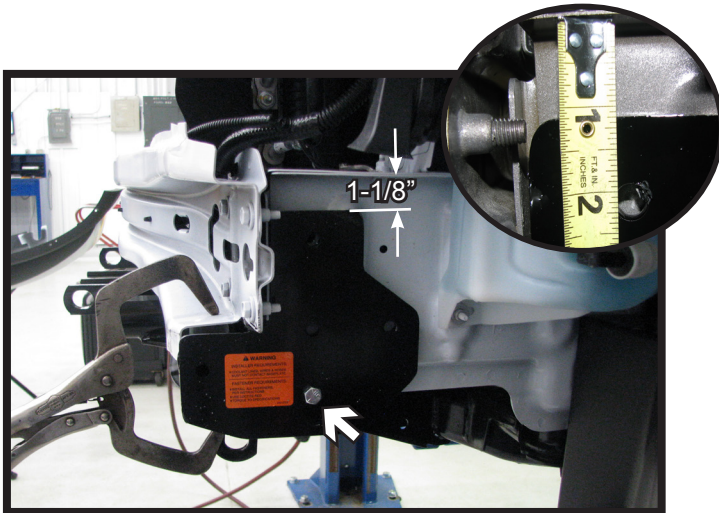

12. Slide the baseplate onto the frame until it is 1-1/8" from the baseplate to the top of the frame (inset). Level and clamp the baseplate securely. Using a 13/32" drill bit, drill the bottom hole in the baseplate thru the frame. Install a 3/8"-16 x 1-1/2" bolt into the hole and install a 3/8" lock washer and lock nut on the inside of the frame. Do this on both sides of the vehicle. Recheck the baseplate is level and fully tighten all hardware.

Note: On 2015-17 models the lower lip of the bumper may need to be trimmed around the convenience link & attachment tube (right).

\*\* Use Loctite® Red on all bolt threads and tighten all bolts to the appropriate torque.

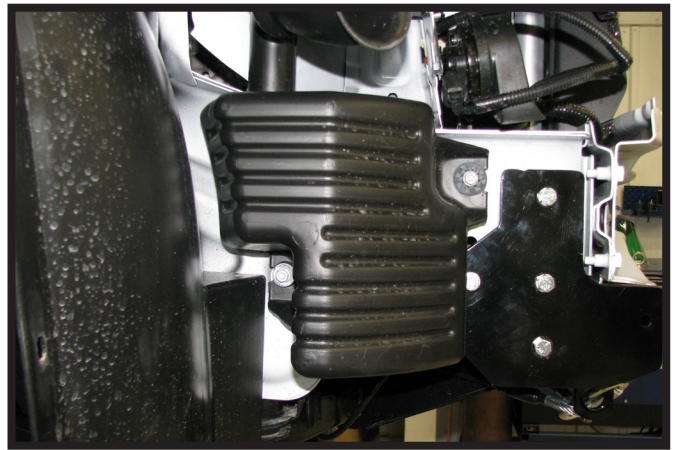
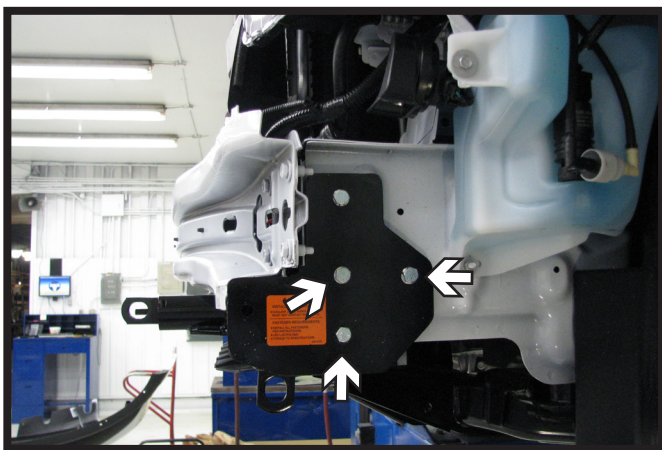

13. Using a 13/32" drill bit, drill the remaining holes thru the frame. Install the 3/8"-16 hardware into the holes with 3/8" nut plates inside of the frame. Do this on both sides of the vehicle. Fully tighten all hardware.

Note: On the rear driver side hole, there is a nut on the inside of the frame that will need to be knocked off after drilling.

\*\* Use Loctite® Red on all bolt threads and tighten all bolts to the appropriate torque.

14. Reinstall the air baffle. Putting three (3) washers behind the air baffle on each stud to space the air baffle out from the frame.

BX1689  
2010-17 Chevy Equinox (All Trims)  
2010-17 GMC Terrain/Terrain Denali (All Trims)  
Installation Instructions

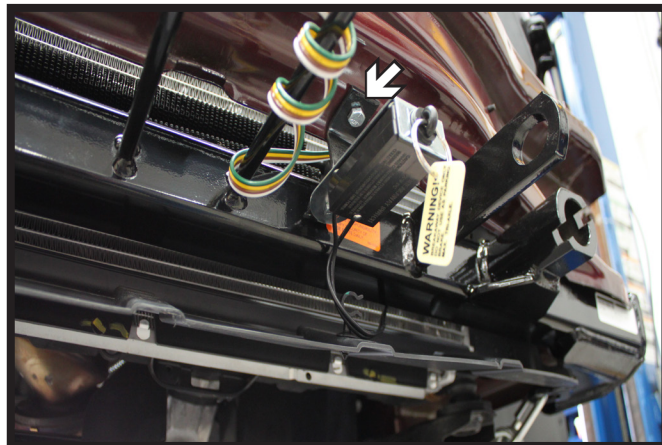
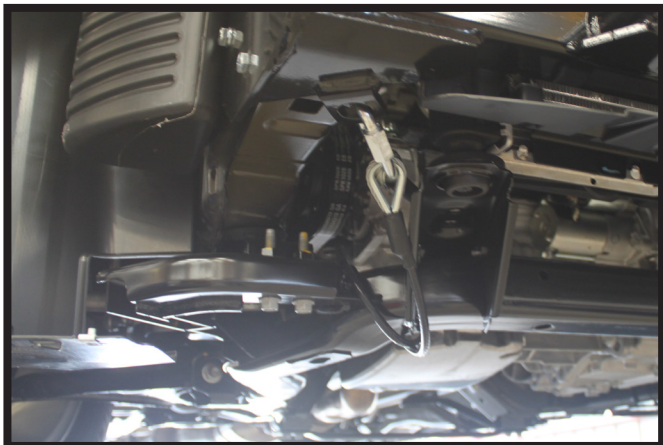

15. Attach the permanent baseplate safety cables to the provided convenience link on the baseplate. The photo above shows the recommended installation of the cables to frame of vehicle. Additional options may interfere with suggested mounting; in this case, secure the cables to a solid piece of the frame as described in the instructions included with the permanent baseplate safety cables. Be sure the safety cables do not rub against any hoses or moving parts. Do this on **BOTH** sides of the vehicle.

16. **Optional:** Using a 9/32" drill bit, drill a hole into the bottom side of the bumper centered between the electrical rod and the convenience link. Attach the bracket with 1/4"-20 x 3/4" bolt and 1/4"-20 nut (white). Fasten the breakaway to the bracket with a 1/4"-20 x 3/4" bolt and 1/4"-20 nut.

**2016-17 Equinox:** The electrical rods may need to be adjusted or slightly bent for the electrical plug to work with this vehicle.

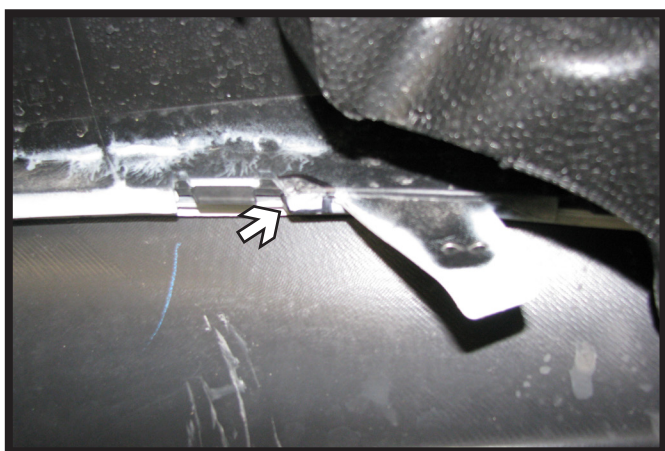

17. **2010-15 Terrain:** Trim off the corner next to the flap to allow for baseplate clearance. Do this on both sides of the fascia.

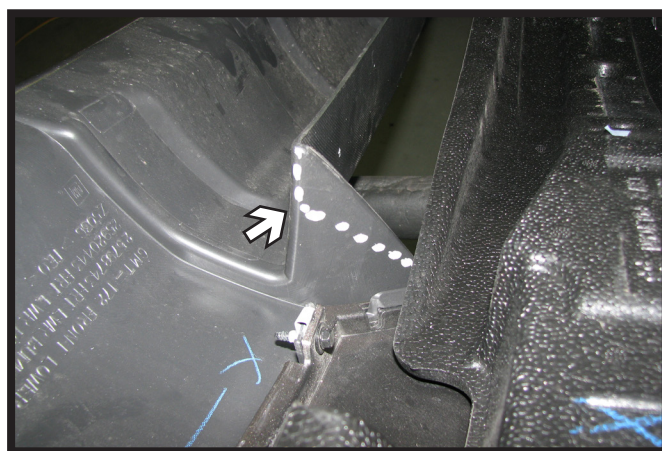

17. **2010-13 Equinox:** Trim the ends of the opening approximately 1" down on the bottom then tapered back to top.



BX1689  
2010-17 Chevy Equinox (All Trims)  
2010-17 GMC Terrain/Terrain Denali (All Trims)  
Installation Instructions



17. **2014 Equinox:** Trim off the end of the styrofoam support above the opening (left). On the end of the opening, trim along the seam as shown (right-black). Then as needed trim off the material between the tabs as needed to clear the baseplate (right-white).



17. **2015-17 Equinox:** Trim off the end of the styrofoam support above the opening (left). On the end of the opening, trim along the seam as shown (right).

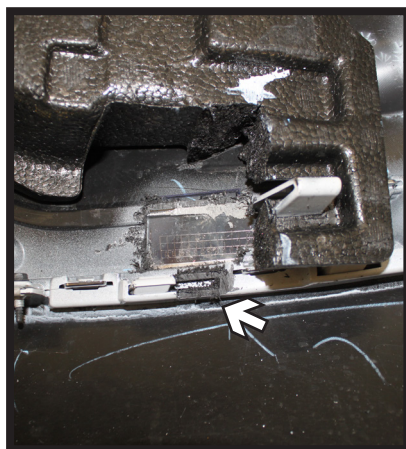

17. **2016-17 Terrain:** Trim off the end of the styrofoam support and thru the first layer of the fascia in the area as shown (left).

An additional area may need to be trimmed thru the first layer as well depending on the fitment just below the main area (right).

BX1689  
2010-17 Chevy Equinox (All Trims)  
2010-17 GMC Terrain/Terrain Denali (All Trims)  
Installation Instructions



18. If equipped, reinstall the cooler to the existing tabs with the supplied brackets and 1/4" hardware in between the baseplate and radiator.



19. Secure the temperature sensor in the desired location (inset). Reinstall the fascia.

## CUSTOMER SERVICE COMMITMENT

Blue Ox® is committed to providing you with exceptional customer care throughout your lifetime with our products. Our team is here to assist you with any questions you may have regarding the performance of your product. Simply call (402) 385-3051 and you can speak with our technical service team.

Additionally, please visit our website to see which rallies our Destination America team will be attending. For a nominal fee, our service technician will service your towing system to ensure it's in proper working condition. Also, as a commitment to our customers, should you visit our factory, you can stay at our full service Blue Ox® campground at no charge along with enjoying a factory tour.

Again, thank you for being our customer and for the confidence you have shown in the performance of our products. It is because of customers like you we enjoy the success we have today.

© 2015 Blue Ox  
One Mill Road, Industrial Park  
Pender, Nebraska 68047  
Phone: (402) 385-3051  
Fax: (402) 385-3360  
www.blueox.com

# General Information

1. Ensure that your product(s) are registered online at [www.blueox.com](http://www.blueox.com). It is crucial to register your product(s) so that you may be alerted of product offerings, updates, upgrades, maintenance and safety bulletins, and/or recalls.
2. **It is the owner's responsibility to inspect all towing equipment for cracked welds, missing or worn parts and loose bolts before each towing trip.** Be sure to use Loctite® Red on all bolts and tighten to the recommended specifications.
3. **It is the owner's responsibility to hook up all towing equipment per manufacturer's instructions/recommendations.**
4. Remove the attachment tabs when not in use (if applicable).

## Notice To Baseplate Installer

### 1. It is YOUR responsibility to watch for:

- Oil cooler and air conditioner lines
- Electrical wires and hoses
- Missing parts or attaching points on the frame

\*\* If the baseplate is improperly installed and is against a wire or hose, it could cause fluid leaks or electrical shorts some time after the actual baseplate installation.

## Permanent Baseplate Safety Cable Installation

Permanent baseplate safety cables are strongly recommended when towing a vehicle with a tow bar. The principle function of the permanent baseplate safety cables is to prevent the towed vehicle from breaking loose in the event the connection between the frame of the towed vehicle and the baseplate fails or becomes disconnected. The cables must be connected from the baseplate to the frame rail or cross member of the vehicle's frame. The illustrations below show the possible arrangements recommended by Blue Ox®. Each permanent baseplate safety cable must have an adequate weight rating for the towing system. The weight rating of the two (2) cables together will not qualify.

***Do not mount the permanent baseplate safety cables against wires, hoses or brake lines.***

These permanent baseplate safety cables should remain installed as long as the baseplate is installed on the vehicle. Permanent baseplate safety cables are to be used in conjunction with, and NOT a replacement for legally required safety cables attaching the towed vehicle to the towing vehicle.

### Option #1

(Baseplates with Convenience Link Tabs)



### Option #2

(Baseplates with out Convenience Link Tabs)



# BLUE OX ORIGINAL PURCHASERS THREE YEAR LIMITED WARRANTY

Automatic Equipment Manufacturing Company ("Automatic") warrants to the original (first) retail purchaser that this product, manufactured by Automatic, shall be free from defect in material and workmanship under normal use and service for a period of three years from the date of delivery.

During said three-year period, Automatic will repair or replace any parts that have been returned by the original purchaser, to the factory, transportation prepaid, and in Automatic's sole and absolute opinion found to be defective.

Limitations on Warranty Coverage:

Coverage under this warranty will be valid only if the customer warranty card is returned by the original purchaser within 30 days of purchase.

Coverage under this warranty will be effective only when a copy of the original invoice, showing date and place of purchase, accompanies any claim for warranty. This warranty is NON TRANSFERABLE.

This limited warranty will not cover, in any way or form, any alleged damages caused by incorrect or improper installation, improper use, modification or neglect of product, failure to properly service and maintain, misuse, act of God, accident or failure of the user to follow guidelines contained in the instructional material provided by Automatic.

This warranty does not cover normal wear and tear, paint or rust.

Warrantor assumes no responsibility to the owner for loss of use of product, loss of time, inconvenience or any other damage consequential or otherwise. Including, but not limited to mileage, expense of transporting of product, return shipping expense, mechanics travel time, telephone, road service, towing, and rental during repairs, travel, lodging, loss or damage to personal property or loss of earnings.

**REPAIR OR REPLACEMENT AS SET FORTH IN THIS LIMITED WARRANTY IS THE SOLE EXCLUSIVE REMEDY OF THE PURCHASER. AUTOMATIC SHALL NOT BE LIABLE FOR ANY INCIDENTAL OR CONSEQUENTIAL DAMAGES FOR BREACH OF ANY EXPRESS OR IMPLIED WARRANTY ON THIS PRODUCT. EXCEPT TO THE EXTENT PROHIBITED BY APPLICABLE LAW, ANY IMPLIED WARRANTY OF MERCHANTABILITY OR FITNESS FOR A PARTICULAR PURPOSE ON THIS PRODUCT IS LIMITED IN LENGTH TO THE DURATION OF THIS WARRANTY.**

Please visit <http://blueox.com/warranty/> to register your warranty

