



BX1131

2011 Jeep Liberty Renegade 2012 Jeep Liberty Sport

Installation Instructions

Attachment Tab Height: 17.5"

Attachment Tab Width: 24"

Serial Number

Please read BOTH these Installation Instructions and the General Instructions prior to installing or operating this equipment.

- Blue Ox® towing products and accessories are intended to be installed by Blue Ox® Dealers who are familiar with our products and have the equipment and knowledge necessary to do "fit work". Blue Ox® Dealers can be found at www.blueox.com or by contacting our Customer Care Department at (402) 385-3051.
- Many Blue Ox® baseplates are designed to use existing holes and hardware to mount the baseplate to the towed vehicle. Do not assume existing hardware will be adequate for baseplate mounting. Always use hardware supplied in the hardware kit and existing hardware specified in the Installation Instructions.



If the front of your vehicle looks different than this, please call us at (402)385-3051.

Reference your vehicle owner's manual for manufacturer's towing specifications.

Bolt Torque Specifications

Torque in Foot-Pounds for Metric Bolts

Bolt Size	Grade 8.8	Grade 10.9
6MM	6	8
8MM	16	22
10MM	31	40
12MM	54	70
14MM	89	117

Bolt Torque Specifications

Torque in Foot-Pounds for Inch Bolts

Bolt Size	Grade 5	Grade 8
1/4"	10	14
5/16"	19	29
3/8"	33	47
7/16"	54	78
1/2"	78	119

WARNING

Failure to read and follow these instructions could result in separation of the towed vehicle from the tow bar, causing property damage, loss of towed vehicle, personal injury or death.



BX1131 2011 Jeep Liberty Renegade 2012 Jeep Liberty Sport Installation Instructions

Removable Tabs: Motorhome mounted tow bars are recommended for use with this baseplate. Due to the design of the removable tabs, the RangeFinderII can not be used. Adapters, except the BX8833 and BX88151, can not be used with this baseplate.

Instruction Notes: The fascia is removed and reinstalled for the baseplate installation. Drilling is required. Some trimming may also be required.

The dimensional variations between otherwise identical vehicles can be considerable. While the baseplate was designed for easy installation, it may be necessary to tailor the baseplate slightly to compensate for auto manufacturer's tolerances. These minor adjustments may include filing a hole slightly, bending electrical rods or bending end plates.

The BX8869 Tail Light Wiring Kit is recommended for this vehicle.

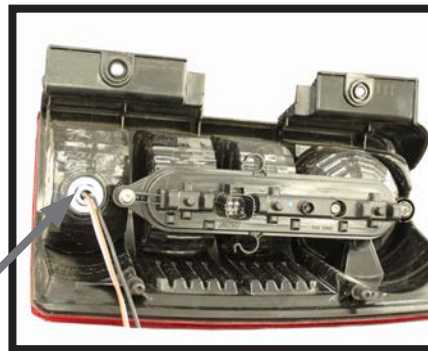
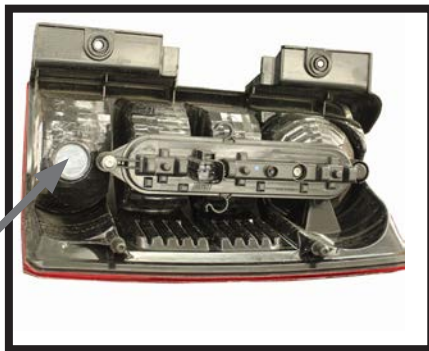

Remove the plastic cap in the tail light assembly and insert 3 wire automotive socket according to the BX8869 installation instructions.



BX1131

2011 Jeep Liberty Renegade 2012 Jeep Liberty Sport Installation Instructions

Tools Required

- 10MM Socket
- 9/16" Socket
- T25 Torx
- 13/32" Drill
- Large Vise Grip
- Flat Screwdriver
- Tape Measure
- Drill
- Utility Knife
- Torque Wrench
- Loctite® RED

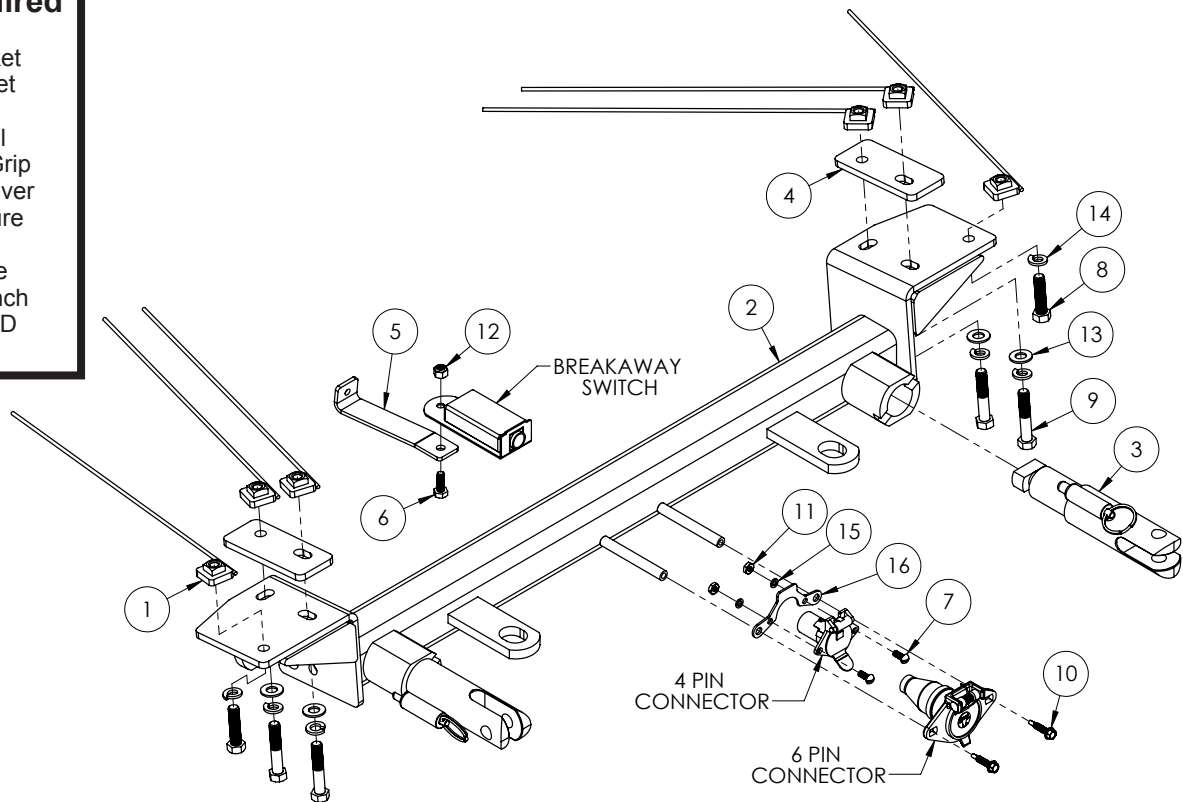

Item No.	Part No.	Description	Qty.
1.....	61-5208.....	3/8"-16 Nut Plate Weldment with 14" Wire	6
2.....	61-6906.....	BX1131 Baseplate Weldment	1
3.....	62-3468.....	Attachment Tab Assembly with Hole.....	2
4.....	102-6572.....	BX1976 Backing Plate	2
5.....	102-7256.....	BX1131 Breakaway Bracket	1
6.....	201-0050.....	1/4"-20 x 3/4" Hex Head Bolt, Grade 5, ZP.....	1
7.....	201-0192.....	#10-32 1/2" Round Slotted Head Screw	2
8.....	201-0440.....	3/8"-16 x 1-1/2" Hex Head Bolt, Grade 5, ZP	2
9.....	201-0444.....	3/8"-16 x 2" Hex Head Bolt, Grade 5, ZP.....	4
10.....	201-0979.....	#12-14 x 1" Self Drilling Screw, ZP	2
11.....	202-0047.....	#10-32 Hex Nut.....	2
12.....	202-0102.....	1/4"-20 Hex Nut with Nylon Insert, ZP	1
13.....	203-0003.....	3/8" Flat Washer, ZP.....	4
14.....	203-0010.....	3/8" Lock Washer, ZP	6
15.....	203-0054.....	#10 Lock Washer	2
16.....	299-0685.....	Electrical Bracket, ZP.....	1
17.....	226-0046 (not shown).....	Class III 36" Baseplate Safety Cable	2
18.....	229-0359 (not shown).....	3/8" Quicklink, ZP	2
19.....	229-0536 (not shown).....	6.3MM Plastic Rivots	4
20.....	290-0437 (not shown).....	Black Receiver Cap Plug	2

Important

Use only genuine factory replacement parts on your baseplate. Do NOT substitute homemade or non-typical parts. If a bolt is lost or in need of replacement, for your safety and the preservation of your baseplate, be sure to use a replacement bolt of the same grade (In most cases it will be Grade 5, please reference the parts list above). Replacement parts may be ordered through your nearest Blue Ox® Dealer or Distributor, or call our Customer Care Team at (402)385-3051. Failing to follow and/or altering these installation instructions in either installation or required equipment will void the manufacturer's warranty.



1. Release the three (3) push pins located in the wheel well area of the vehicle using a flat screwdriver. Then remove the two (2) pop rivets.



2. Release the push pin that is located on the lower portion of the backside of the fascia, directly in front of the tire, using a flat screwdriver.



3. Holding the wheel well liner back, remove the three (3) clips. Do this on both sides of the vehicle.

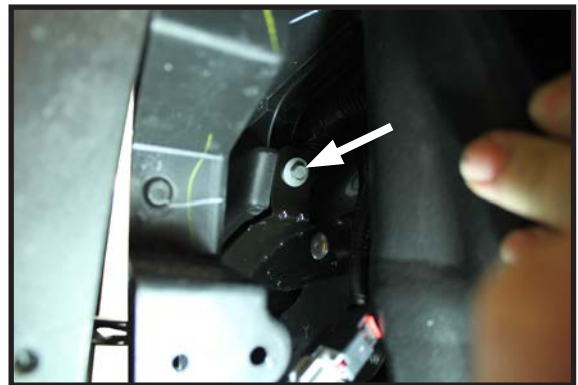

4. With the wheel well liner still pulled back, use a 10MM socket to remove the bolt. Do this on both sides of the vehicle.

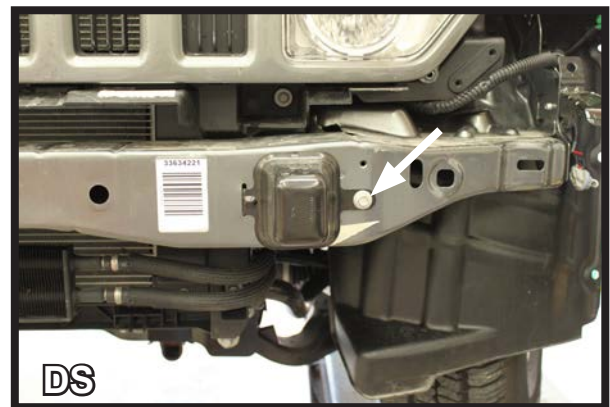
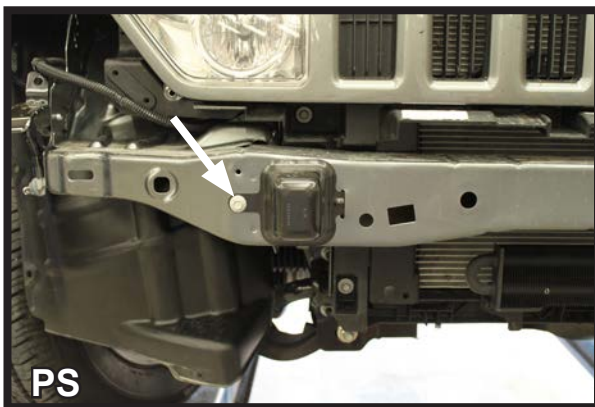

5. Remove cups on the bumper using a 10mm socket. These holes will be used later for nut plate installation for the baseplate.

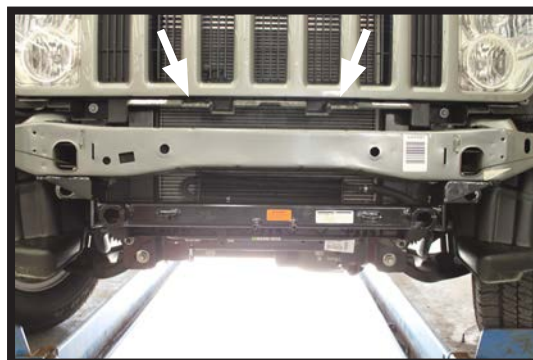

6. Press down gently on the plastic guard located beneath the grille in order to prevent damage to the guard.

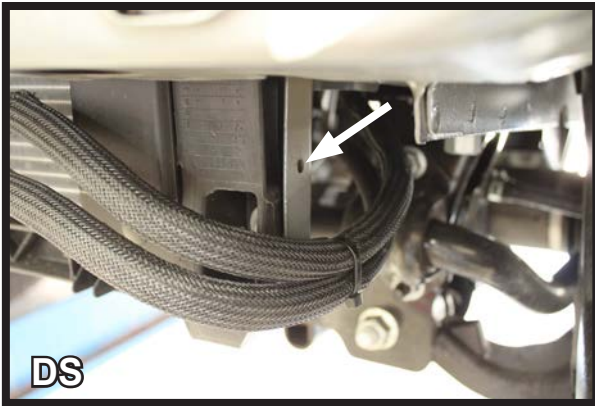

7. On the driver side only, move the coolant lines down and remove the push pin.

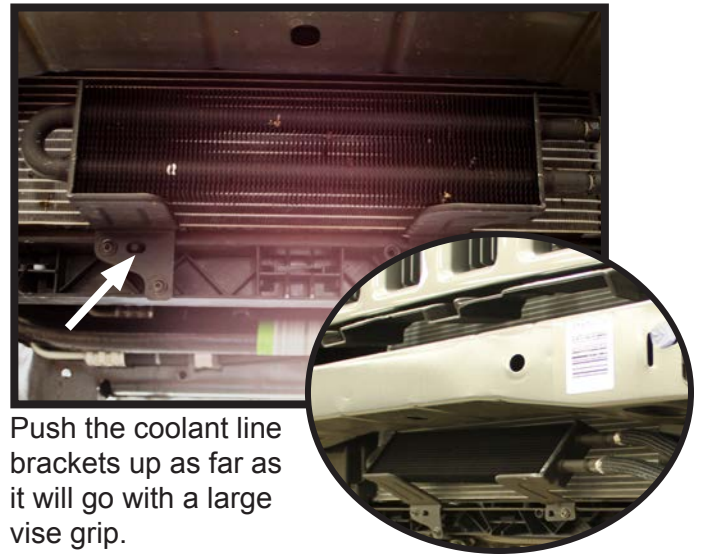

8. Push the coolant line brackets up as far as it will go with a large vise grip.

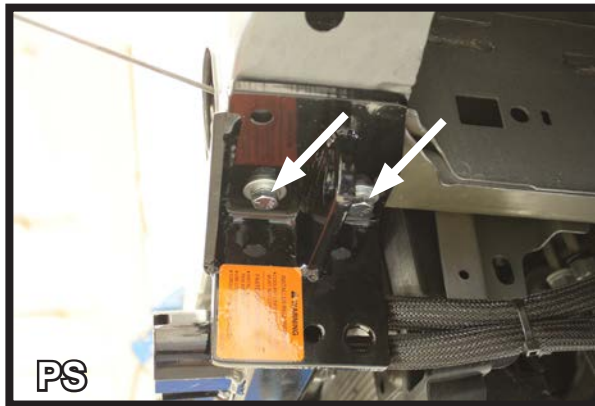

9. Attach baseplate to the underside of the bumper using the existing two (2) holes. Use 3/8"-16 x 2" bolts, 3/8" flat & lock washers and 3/8" nut plates. Use the backing plates on the inside of the frame in between the frame and nut plates.

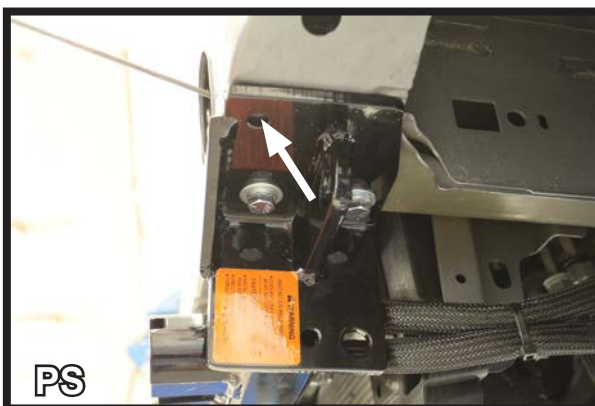
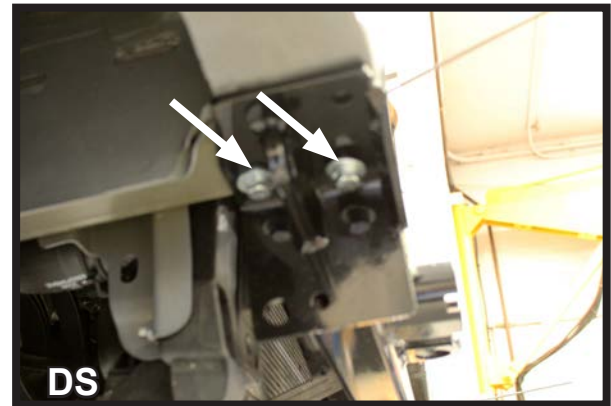

10. Using the endplate as a template, drill an additional hole using a 13/32" drill bit. Install a 3/8"-16 x 1-1/2" bolt, 3/8" lock washer and 3/8" nut plate into hole.





BX1131

2011 Jeep Liberty Renegade 2012 Jeep Liberty Sport Installation Instructions

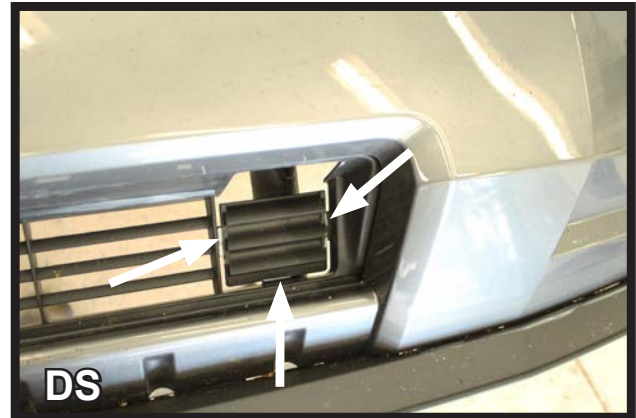
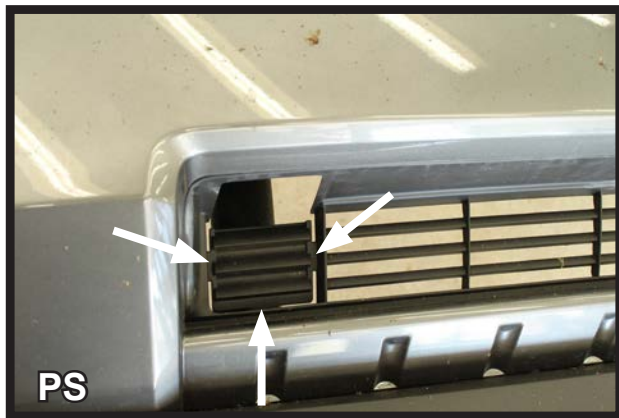

11. Remove the tow hooks if your vehicle is equipped with them. If your vehicle is not equipped with tow hooks, notch the grill as shown in the above diagram
12. Attach the permanent baseplate safety cables to the provided convenience link on the baseplate. Additional options may interfere with suggested mounting; in this case, secure the cables to a solid piece of the frame as described in the instructions included with the permanent baseplate safety cables. Be sure the safety cables do not rub against any hoses or moving parts. Do this on both sides of the vehicle.
13. Reinstall the front fascia. Be sure that all electrical components are plugged in properly.
14. Do not substitute other devices if the tow bar pin and clip are lost.
15. Dealer or installer be certain the end user receives the instruction sheet.

CUSTOMER SERVICE COMMITMENT

Blue Ox® is committed to providing you with exceptional customer care throughout your lifetime with our products. Our team is here to assist you with any questions you may have regarding the performance of your product. Simply call (402) 385-3051 and you can speak with our customer care team.

Additionally, please visit our website to see which rallies our Destination America team will be attending. For a nominal fee, our service technician will service your towing system to ensure it's in proper working condition. Also, as a commitment to our customers, should you visit our factory, you can stay at our full service Blue Ox® campground at no charge along with enjoying a factory tour.

Again, thank you for being our customer and for the confidence you have shown in the performance of our products. It is because of customers like you we enjoy the success we have today.



© 2011 Blue Ox
One Mill Road, Industrial Park
Pender, Nebraska 68047
Phone: (402) 385-3051
Fax: (402) 385-3360
www.blueox.com

General Information

1. Ensure that your product(s) are registered online at www.blueox.com. It is crucial to register your product(s) so that you may be alerted of product offerings, updates, upgrades, maintenance and safety bulletins, and/or recalls.
2. **It is the owner's responsibility to inspect all towing equipment for cracked welds, missing or worn parts and loose bolts before each towing trip.** Be sure to use Loctite® Red on all bolts and tighten to the recommended specifications.
3. **It is the owner's responsibility to hook up all towing equipment per manufacturer's instructions/recommendations.**
4. Remove the attachment tabs when not in use (if applicable).

Notice To Baseplate Installer

1. **It is YOUR responsibility to watch for:**

- Oil cooler and air conditioner lines
- Electrical wires and hoses
- Missing parts or attaching points on the frame

** If the baseplate is improperly installed and is against a wire or hose, it could cause fluid leaks or electrical shorts some time after the actual baseplate installation.

Permanent Baseplate Safety Cable Installation

Permanent baseplate safety cables are strongly recommended when towing a vehicle with a tow bar. The principle function of the permanent baseplate safety cables is to prevent the towed vehicle from breaking loose in the event the connection between the frame of the towed vehicle and the baseplate fails or becomes disconnected. The cables must be connected from the baseplate to the frame rail or cross member of the vehicle's frame. The illustrations below show the possible arrangements recommended by Blue Ox®. Each permanent baseplate safety cable must have an adequate weight rating for the towing system. The weight rating of the two (2) cables together will not qualify.

Do not mount the permanent baseplate safety cables against wires, hoses or brake lines.

These permanent baseplate safety cables should remain installed as long as the baseplate is installed on the vehicle. Permanent baseplate safety cables are to be used in conjunction with, and NOT a replacement for legally required safety cables attaching the towed vehicle to the towing vehicle.

OPTION #1

Permanent Baseplate Safety Cables to Cross Member or Frame of Towed Vehicle.



OPTION #2

Permanent Baseplate Safety Cables to Cross Member or Frame of Towed Vehicle.

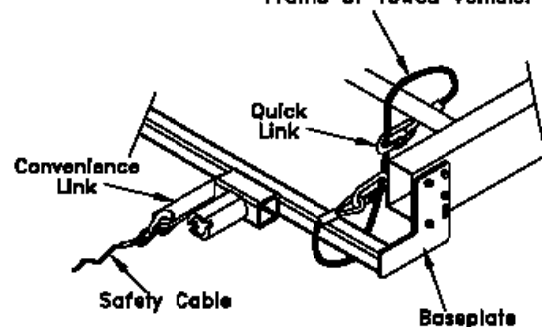

BLUE OX ORIGINAL PURCHASERS ONE YEAR LIMITED WARRANTY

Automatic Equipment Manufacturing Company ("Automatic") warrants to the original (first) retail purchaser that this product, manufactured by Automatic, shall be free from defect in material and workmanship under normal use and service for a period of one year from the date of delivery.

During said one-year period, Automatic will repair or replace any parts that have been returned by the original purchaser, to the factory, transportation prepaid, and in Automatic's sole and absolute opinion found to be defective.

Limitations on Warranty Coverage:

Coverage under this warranty will be valid only if the customer warranty card is returned by the original purchaser within 30 days of purchase.

Coverage under this warranty will be effective only when a copy of the original invoice, showing date and place of purchase, accompanies any claim for warranty. This warranty is NON TRANSFERABLE.

This limited warranty will not cover, in any way or form, any alleged damages caused by incorrect or improper installation, improper use, modification or neglect of product, failure to properly service and maintain, misuse, act of God, accident or failure of the user to follow guidelines contained in the instructional material provided by Automatic.

This warranty does not cover normal wear and tear, paint or rust.

Warrantor assumes no responsibility to the owner for loss of use of product, loss of time, inconvenience or any other damage consequential or otherwise. Including, but not limited to mileage, expense of transporting of product, return shipping expense, mechanics travel time, telephone, road service, towing, and rental during repairs, travel, lodging, loss or damage to personal property or loss of earnings.

REPAIR OR REPLACEMENT AS SET FORTH IN THIS LIMITED WARRANTY IS THE SOLE EXCLUSIVE REMEDY OF THE PURCHASER. AUTOMATIC SHALL NOT BE LIABLE FOR ANY INCIDENTAL OR CONSEQUENTIAL DAMAGES FOR BREACH OF ANY EXPRESS OR IMPLIED WARRANTY ON THIS PRODUCT. EXCEPT TO THE EXTENT PROHIBITED BY APPLICABLE LAW, ANY IMPLIED WARRANTY OF MERCHANTABILITY OR FITNESS FOR A PARTICULAR PURPOSE ON THIS PRODUCT IS LIMITED IN LENGTH TO THE DURATION OF THIS WARRANTY.

Please visit <http://blueox.com/warranty/> to register your warranty

